

M5 Compact System

Key features

FESTO



-  - Flow rate
100 l/min

- Forms the basis for compact pneumatic control systems
- M5 elements with 2n sub-bases
- Control cabinet installation
- Easy mounting
- Fast replacement of components
- Barbed fitting connection for 3 mm plastic tubing

The M5 Compact System is a complete system offering control components with all the functions required for pneumatic sequence controls. These all feature 2n sub-bases and barbed fitting connections for 3 mm plastic tubing.

For basic valves and actuators for panel mounting for use as signal components for basic functions such as START, STOP, etc.
→ Internet: sv

M5 Compact System

Key features

FESTO

Mounting the components

Each mounting frame can be used to mount up to 16 components of the M5 Compact System using 2N sub-bases. The frames are 480 mm long and have been designed for use with 19" housings to DIN 41 488. The rails can be shortened to allow for other types of installation.

Components are attached by sliding their sub-bases or mounting plates into the guide slot of the profile rails. The sub-bases or plates are then clamped between the cross bars.

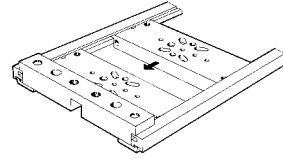

They can also be placed onto the frame and screwed down individually.

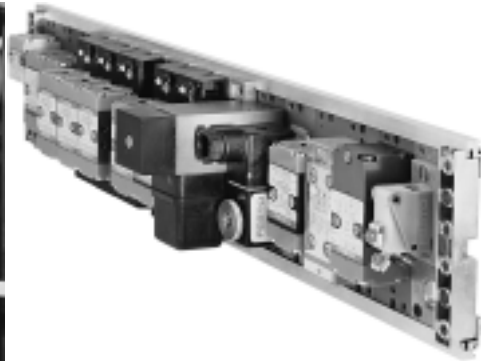

M5 Compact System

Product range overview

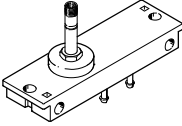
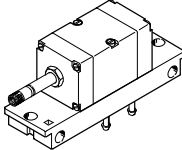
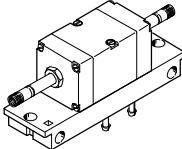
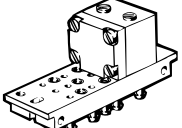
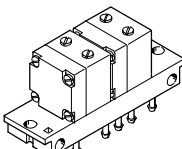
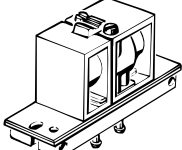
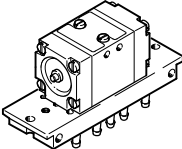

Function	Version	Type	Brief description	Operating pressure [bar]	→ Page/Internet
Solenoid valves	3/2-way valves				
		MUFH-3-PK-3	Mechanical spring return for mounting frame 2N	0 ... 8	6
	5/2-way valves				
		MFH-5-PK-3	Mechanical spring return for mounting frame 2N	3 ... 8	6
		MFH-5-PK-3-L	Pneumatic spring return for mounting frame 2N	1.5 ... 8	6
	JMFH-5-PK-3	Double solenoid valve for mounting frame 2N	2 ... 8	6	
Pneumatic valves	3/2-way valves				
		VL/O-3-PK-3	Mechanical spring return for mounting frame 2N	0 ... 8	10
		VL/O-3-PK-3x2	2 pneumatic valves on one sub-base Mechanical spring return for mounting frame 2N	0 ... 8	10
		J-3-PK-3	Double pilot valve for mounting frame 2N	-0.9 ... 8	10
	5/2-way valves				
		VL-5-PK-3	Mechanical spring return for mounting frame 2N	0 ... 8	10
		J-5-PK-3	Double pilot valve for mounting frame 2N	1 ... 8	10
JD-5-PK-3		Double pilot valve with dominating signal at 14 for mounting frame 2N	1 ... 8	10	

M5 Compact System

Product range overview

FESTO

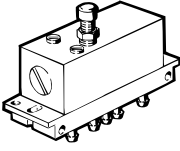
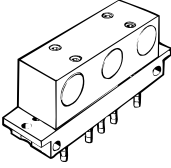
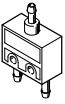
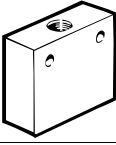
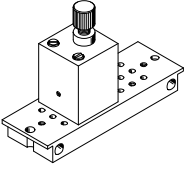
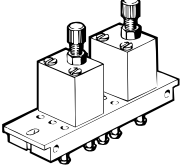
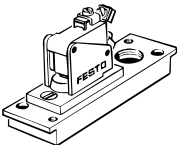
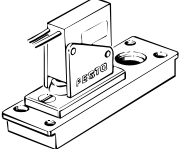
Function	Version	Type	Brief description	Operating pressure [bar]	→ Page/Internet
Time delay valves	Time delay valves				
		VZ-3-PK-3	With switch-on delay for mounting frame 2N	2.5 ... 8	13
		VZO-3-PK-3	With switch-off delay for mounting frame 2N	2.5 ... 8	13
Logic components	AND/OR blocks				
		OS-PK-3-6/3	3 OR gates for mounting frame 2N	1.6 ... 8	15
		ZK-PK-3-6/3	3 AND gates for mounting frame 2N	1.6 ... 8	15
		OS-PK-3	OR gate	1.6 ... 8	25
		ZK-PK-3	AND gate	1.6 ... 8	25
		OS-1/8-B	OR gate	1 ... 10	25
		ZK-1/8-B	AND gate	1 ... 10	25
		OS-1/4-B	OR gate	1 ... 10	25
		OS-1/2	OR gate	1 ... 10	25
	One-way flow control valves	One-way flow control valves			
		GRF-PK-3	For mounting frame 2N	0.5 ... 8	16
		GRF-PK-3x2	2 one-way flow control valves on one sub-base for mounting frame 2N	0.5 ... 8	16
PE converters	Pneumatic/electrical pressure transducers				
		PE-1/8-2N	For mounting frame 2N	0 ... 8	18
		PE-1/8-2N-SW	Splash proof design for mounting frame 2N	0 ... 8	18

M5 Compact System

Product range overview

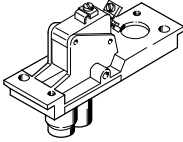
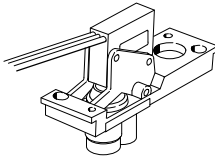
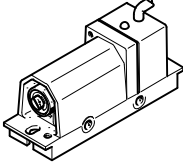
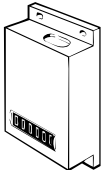
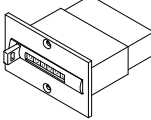
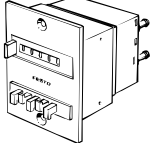
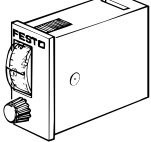

Function	Version	Type	Brief description	Operating pressure [bar]	→ Page/Internet
PE converters	Pneumatic/electrical pressure transducers				
		VPE-1/8-2N	Vacuum switch for mounting frame 2N	-0.95 ... 0	18
		VPE-1/8-2N-SW	Vacuum switch splash proof design for mounting frame 2N	-0.95 ... 0	18
	Pneumatic/electrical differential pressure switch				
		PEN-M5	For mounting frame 2N	-1 ... 8	22
Pneumatic counters	Adding counters				
		PZA-A-B	Base mounting	2 ... 8	27
		PZA-E-C	Panel mounting	2 ... 8	27
	Predetermining counter				
		PZV-E-C	Panel mounting	2 ... 8	27
Pneumatic timer	Pneumatic timer				
		PZVT-3-C PZVT-30-C PZVT-12-C PZVT-300-C	Clamping frame	2 ... 6	33
		PZVT-AUT	Automatic reset module	2 ... 6	33

Solenoid valves MUFH/MFH/JMFH, for mounting frame 2N

FESTO

Technical data

3/2-way valves
MUFH-3-PK-3

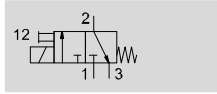

- - Flow rate
50 l/min
- - Operating pressure
0 ... 8 bar



5/2-way valves
MFH-5-PK-3

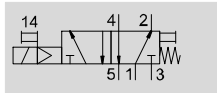

JMFH-5-PK-3

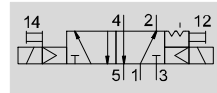

MFH-5-PK-3-L

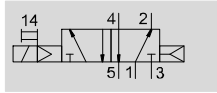

- - Flow rate
105 l/min
- - Operating pressure
1.5 ... 8 bar

General technical data					
Type	3/2-way valves		5/2-way valves		
	MUFH-3-PK-3	MFH-5-PK-3	MFH-5-PK-3-L	JMFH-5-PK-3	
Pneumatic connection 1, 2	PK-3				
Pneumatic connection 3	M5	PK-3			
Pneumatic connection 4, 5	-		PK-3		
Nominal size [mm]	1.3	2.5			
Design	Poppet seat				
Type of mounting	On sub-base				
	On mounting frame				
	Via through-hole				
Mounting position	Any				
Valve function	3/2-way valve, closed, single-solenoid	5/2-way valve, single-solenoid	5/2-way valve, single-solenoid	5/2-way valve, double-solenoid	
Sealing principle	Soft				
Response time	Off [ms]	22	22	22	-
	On [ms]	15	10	14	-
	Changeover [ms]	-	-	-	13

Operating and environmental conditions					
Type	3/2-way valves		5/2-way valves		
	MUFH-3-PK-3	MFH-5-PK-3	MFH-5-PK-3-L	JMFH-5-PK-3	
Operating pressure [bar]	0 ... 8	3 ... 8	1.5 ... 8	2 ... 8	
Operating/pilot medium	Compressed air to ISO 8573-1:2010 [7:-:-]				
Ambient temperature [°C]	-5 ... +40	-5 ... +40	-5 ... +40	0 ... +40	
Temperature of medium [°C]	-10 ... +60	-10 ... +60	-10 ... +60	0 ... +60	
Certification	c CSA us (OL)	-	-	-	

Solenoid valves MUFH/MFH/JMFH, for mounting frame 2N

Technical data

Materials				
Type	3/2-way valves	5/2-way valves		
	MUFH-3-PK-3	MFH-5-PK-3	MFH-5-PK-3-L	JMFH-5-PK-3
Housing	Anodised aluminium			
Sub-base	Anodised aluminium			
Seals	NBR			
Note on materials	-	RoHS-compliant	RoHS-compliant	RoHS-compliant

Dimensions – 3/2-way valves Download CAD data → www.festo.com

MUFH-3-PK-3

1 Barbed fitting PK-3 for plastic tubing
 2 Manual override
 3 Rotatable solenoid coil

Type	B1	B2	D1	D2	D3	H1	H2	H3	H4	H5	H6	H7	L1	L2	L3	L4	L5	L6	L7	L8	L9	L10
MUFH	26.8	16	4.5	M4	M5	10	7.7	5	6	27	58	~72	88.5	80.8	74	75	81	61	39	8	28	2.3

Solenoid valves MUFH/MFH/JMFH, for mounting frame 2N

Technical data



Dimensions – 5/2-way valves

Download CAD data → www.festo.com

MFH-5-PK-3(-L)

JMFH-5-PK-3

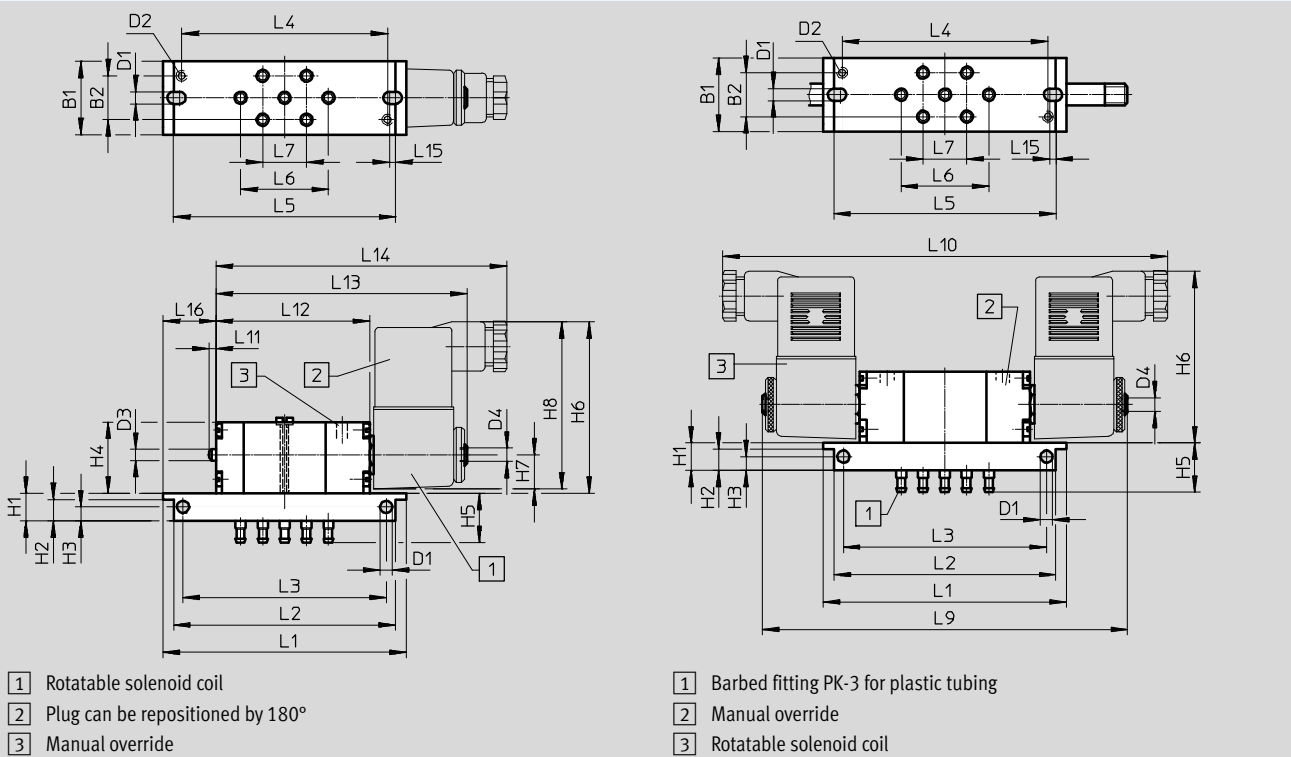



Type	B1	B2	D1	D2	D3	D4	H1	H2	H3	H4	H5	H6	H7	H8
MFH	26.8	16	4.4	M4	4	M5	10	7.7	5	26	18.5	62.5	12.5	61
JMFH					-					-				

Type	L1	L2	L3	L4	L5	L6	L7	L9	L10	L11	L12	L13	L14	L15	L16
MFH	88.5	80.8	74	75	81	32	16	-	-	2.5	56	~90	~106	2.3	19
JMFH								133	162	-	-	-	-		-

Ordering data						
	Function	Pneumatic connection	Standard nominal flow rate q _N [l/min]	Weight [g]	Part No.	Type
3/2-way valves						
	Closed, single-solenoid, mechanical spring return	PK-3, M5	50	120	6705	MUFH-3-PK-3
5/2-way valves						
	Single-solenoid, mechanical spring return	PK-3	105	270	4448	MFH-5-PK-3
	Single-solenoid, pneumatic spring return	PK-3	105	270	11546	MFH-5-PK-3-L
	Double-solenoid	PK-3	105	380	4447	JMFH-5-PK-3

Solenoid valves MUFH/MFH/JMFH, for mounting frame 2N

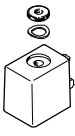
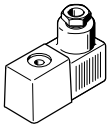
Accessories

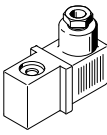
Ordering data – Solenoid coil MSFG/MSFW		Technical data → Internet: msf	
	Description	Operating voltage	Part No. Type
Plug connector to industry standard, type B			
	Without plug socket	12 V DC	34410 MSFG-12DC-OD
		24 V DC, 42 V AC	34411 MSFG-24/42-50/60-OD
		42 V DC	34413 MSFG-42DC-OD
		24 V AC	34415 MSFW-24AC-OD
		48 V AC	34418 MSFW-48AC-OD
		110 V AC	34420 MSFW-110AC-OD
		230 V AC	34422 MSFW-230AC-OD
		240 V AC	34424 MSFW-240AC-OD
	With plug socket	12 V DC	4526 MSFG-12
		24 V DC, 42 V AC	4527 MSFG-24/42-50/60
		24 V AC	4534 MSFW-24-50/60
		110 V AC	6720 MSFW-110-50/60
		230 V AC	4540 MSFW-230-50/60
Plug connector to EN 175301, type A			
	Without plug socket	24 V DC, 42 V AC	34412 MSFG-24/42-50/60-DS-OD
		230 V AC	175118 MSFW-230-50/60-DS-OD
	With plug socket, plug connector can be repositioned by 180° Certification: Germanischer Lloyd	24 V DC, 42 V AC	13264 MSFG-24/42-50/60-DS
		110 V AC	13265 MSFW-110-50/60-DS
		230 V AC	13266 MSFW-230-50/60-DS

Pneumatic valves VL/J, for mounting frame 2N

Technical data

3/2-way valves

VL/O-3-PK-3

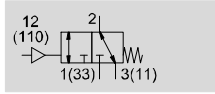

VL/O-3-PK-3x2

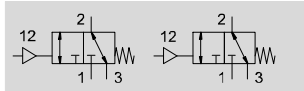

- - Flow rate
100 l/min
- - Temperature range
-10 ... +6 0°C
- - Operating pressure
0 ... 8 bar

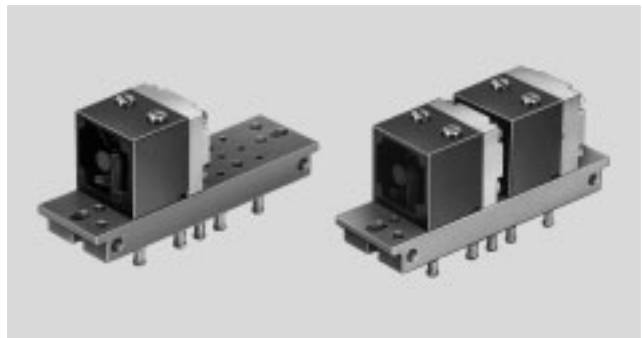

J-3-PK-3

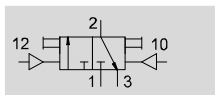

- - Flow rate
100 l/min
- - Temperature range
-10 ... +60 °C
- - Operating pressure
-0.9 ... 8 bar



5/2-way valves

VL-5-PK-3

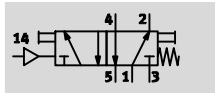

JD-5-PK-3

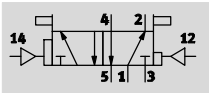

- - Flow rate
105 l/min
- - Operating pressure
0 ... 8 bar



J-5-PK-3

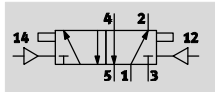

General technical data

Type	3/2-way valves			5/2-way valves		
	VL/O-3-PK-3	VL/O-3-PK-3x2	J-3-PK-3	VL-5-PK-3	J-5-PK-3	JD-5-PK-3
Pneumatic connection 1 ... 5	PK-3					
Auxiliary pilot air port 10	-	-	PK-3	-	-	-
Auxiliary pilot air port 12	PK-3	PK-3	PK-3	-	PK-3	PK-3
Auxiliary pilot air port 14	-	-	-	PK-3	PK-3	PK-3
Nominal width [mm]	2.5					
Design	Poppet seat	Poppet seat	Piston spool valve	Poppet seat	Poppet seat	Poppet seat
Type of mounting	On sub-base On mounting frame With through-hole					
Mounting position	Any					
Valve function	3/2-way valve, open, monostable	3/2-way valve, open, monostable	3/2-way valve, bistable	5/2-way valve, monostable	5/2-way valve, bistable	5/2-way valve, bistable, dominant ¹⁾
Switching time	Off [ms]	50	50	-	22	-
	On [ms]	12	12	-	15	-
	Changeover [ms]	-	-	7	-	9
	Changeover (dominant) [ms]	-	-	-	-	-

1) Dominant signal at 14.

Pneumatic valves VL/J, for mounting frame 2N

Technical data

Operating and environmental conditions						
Type	3/2-way valves			5/2-way valves		
	VL/O-3-PK-3	VL/O-3-PK-3x2	J-3-PK-3	VL-5-PK-3	J-5-PK-3	JD-5-PK-3
Operating pressure [bar]	0 ... 8	0 ... 8	-0.9 ... 8	0 ... 8	1 ... 8	1 ... 8
Pilot pressure [bar]	See diagram					
Operating/pilot medium	Compressed air to ISO 8573-1:2010 [7:-:-]					
Note on operating/pilot medium	Lubricated operation possible (in which case lubricated operation will always be required)					
Ambient temperature [°C]	-10 ... +60	-10 ... +60	-10 ... +60	-10 ... +60	0 ... +60	0 ... +60
Temperature of medium [°C]	-10 ... +60	-10 ... +60	-10 ... +60	-10 ... +60	0 ... +60	0 ... +60

Materials						
Type	3/2-way valves			5/2-way valves		
	VL/O-3-PK-3	VL/O-3-PK-3x2	J-3-PK-3	VL-5-PK-3	J-5-PK-3	JD-5-PK-3
Housing	Plastic, die-cast zinc					
Sub-base	Brass, PPS-reinforced					
Seals	NBR					
Note on materials	-	-	Contains PWIS (paint-wetting impairment substances)	RoHS-compliant	RoHS-compliant	RoHS-compliant

Minimum pilot pressure p2 as a function of operating pressure p1

3/2-way valves

VL/O-3-PK-3, VL/O-3-PK-3x2

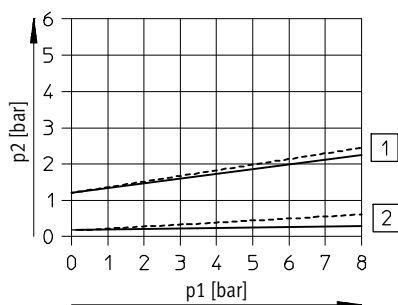

J-3-PK-3

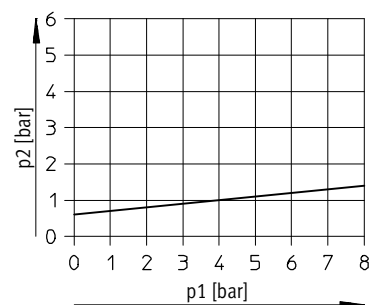

— Exhaust throttled
 - - - - - Exhaust unthrottled

- 1 Switch-on pressure
- 2 Switch-off pressure

5/2-way valves

VL-5-PK-3

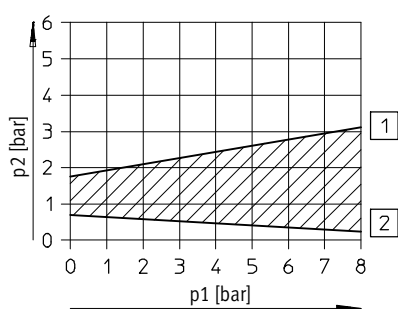

J-5-PK-3, JD-5-PK-3

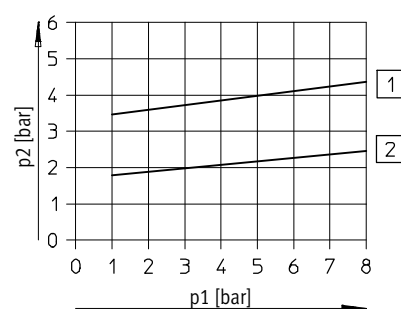

- 1 Switch-on pressure
- 2 Switch-off pressure

- 1 JD-5-PK-3
- 2 J-5-PK-3

Pneumatic valves VL/J, for mounting frame 2N

Technical data

FESTO

Download CAD data → www.festo.com

3/2-way valves		5/2-way valves
VL/O-3-PK-3, VL/O-3-PK-3x2	J-3-PK-3	VL-5-PK-3, J-5-PK-3, JD-5-PK-3
<p>1 Barbed connector for plastic tubing PK-3</p>	<p>1 Barbed connector for plastic tubing PK-3</p> <p>2 Manual override</p>	<p>1 Barbed connector for plastic tubing PK-3</p> <p>2 Manual override</p>

Ordering data					
Function	Pneumatic connection	Standard nominal flow rate qnN [l/min.]	Weight [g]	Part No.	Type
3/2-way valves					
Open, monostable (1 valve)	PK-3	100	110	4233	VL/O-3-PK-3
Open, monostable (2 valves)			180	4245	VL/O-3-PK-3x2
Bistable			75	10772	J-3-PK-3
5/2-way valves					
Monostable	PK-3	105	130	4504	VL-5-PK-3
Bistable			130	4503	J-5-PK-3
Bistable, dominant ¹⁾			130	4901	JD-5-PK-3

1) Dominant signal at 14.

Time delay valves VZ/VZO, for mounting frame 2N

Technical data

VZ, with switch-on delay

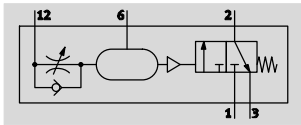

VZO, with switch-off delay

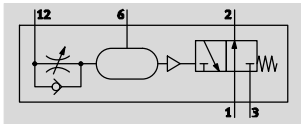

- - Flow rate
60 ... 90 l/min
- - Temperature range
-10 ... +60 °C
- - Operating pressure
2.5 ... 8 bar



The time delay valve consists of a pneumatically actuated 3-way valve

and an upstream throttle with additional volume. The directional

control valve is activated with a delay

depending on the setting of the throttle. It is reset via a mechanical spring.

General technical data		
Type	VZ	VZO
Pneumatic port	PK-3	
Nominal width [mm]	2	
Design	Poppet valve with spring return	
Type of actuation	Pneumatic	
Type of mounting	Front panel mounting On mounting frame	
Mounting position	Any	
Valve function	3/2-way valve, closed, monostable	3/2-way valve, open, monostable
Non-overlapping	No	
Manual override	None	
Exhaust-air function	With flow control	
Type of control	Direct	
Pilot air supply	External	
Direction of flow	Non-reversible	
Sealing principle	Soft	
Adjustable delay time ¹⁾ [s]	0.25 ... 5	
Pause period for reset [ms]	≥ 55	≥ 50
Repetition accuracy of time setting [s]	±0.5	

1) To achieve delay times that are longer than 5s, an additional volume can be connected to barbed connector 6 once the end cap has been removed. A 10 cm³ increase in volume will lengthen the time delay by approx. 5 s. Air pressure reservoir VZS → Internet: vzs

Operating and environmental conditions		
Operating pressure [bar]	2.5 ... 8	
Operating/pilot medium	Compressed air to ISO 8573-1:2010 [7:4:4]	
Note on operating/pilot medium	Lubricated operation not possible	
Ambient temperature [°C]	-10 ... +60	
Temperature of medium [°C]	-10 ... +60	

Materials		
Housing	Die-cast zinc	
Seals	Nitrile rubber	
Note on materials	RoHS-compliant	

Time delay valves VZ/VZO, for mounting frame 2N



Technical data

Minimum pilot pressure p2 as a function of the operating pressure p1

VZ

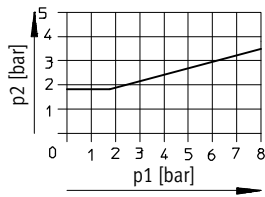

VZO

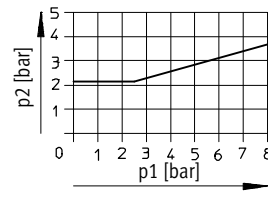

Dimensions

Download CAD data → www.festo.com

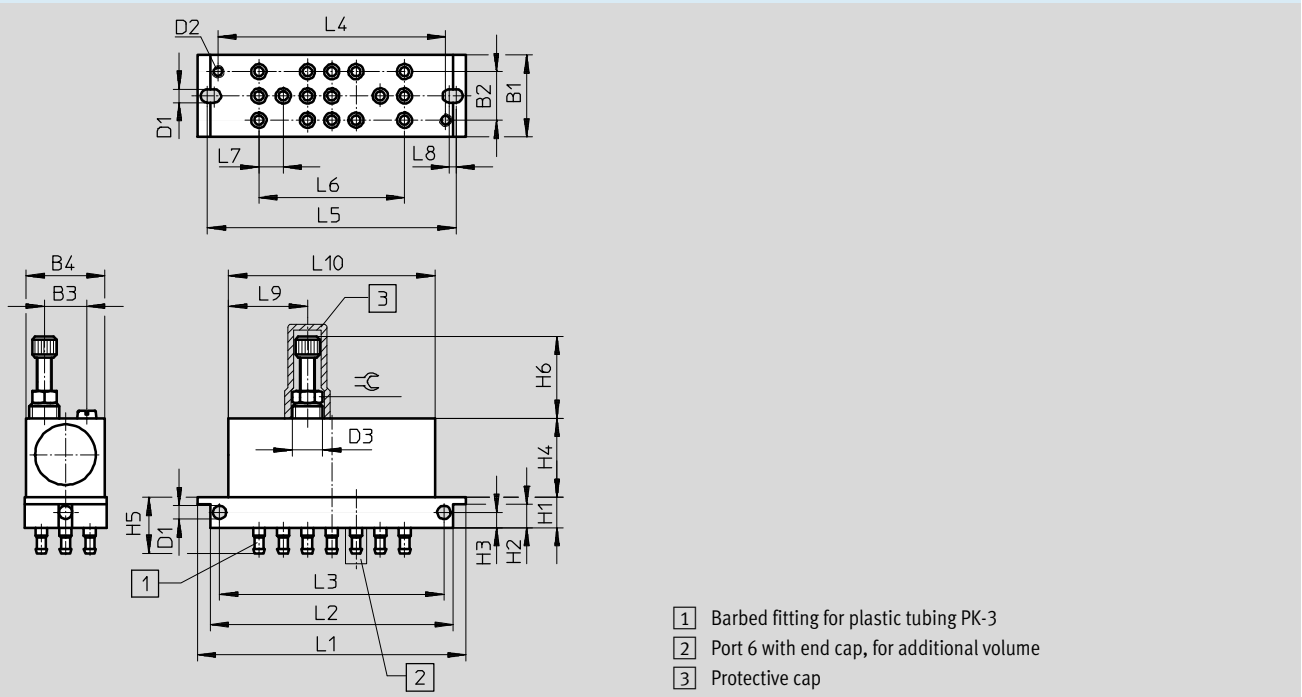

B1	B2	B3	B4	D1 Ø	D2	D3	H1	H2	H3	H4	H5
27	16	14	26	4.4	M4	M10x1	10	7.7	5	26	18.5

H6 Min.	L1	L2	L3	L4	L5	L6	L7	L8	L9	L10	≈
27	88.5	80.8	74	75	81	48	8	2.3	26	68	8

Ordering data

Function	Pneumatic port	Standard nominal flow rate qnN [l/min.]	Weight [g]	Part No.	Type
With switch-on delay	PK-3	90	150	5755	VZ-3-PK-3
With switch-off delay		60	150	5754	VZO-3-PK-3

Ordering data for accessories

Description	Part No.	Type
Cover cap	6436	GRK-M5

AND/OR blocks OS/ZK, for mounting frame 2N

Technical data

General technical data		
	OS-PK-3-6/3	ZK-PK-3-6/3
Valve function	OR function	AND function
Nominal size [mm]	2.5	2.5
Mounting position	Any	
Type of mounting	Via through-holes, front panel mounting, on mounting frame	
Operating medium	Compressed air in accordance with ISO 8573-1:2010 [7:4:4]	
Note on operating/pilot medium	Operation with lubricated medium possible (in which case lubricated operation will always be required)	
Pneumatic connection [mm]	PK-3 for 3 mm tubing I.D.	
Standard nominal flow rate [l/min]	100	
Information on housing materials	POM	POM
Information on seals materials	NBR	NBR
Weight [g]	90	85

Operating and environmental conditions		
Operating pressure [bar]	1.6 ... 8	
Ambient temperature [°C]	-10 ... +60	
Medium temperature [°C]	-10 ... +60	

Dimensions

Download CAD data → www.festo.com

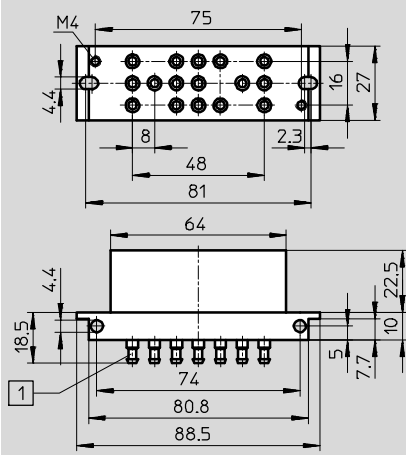

1 Barbed fitting for 3 mm tubing I.D.



Ordering data		Part No.	Type
OR block (3 OR gates)		4232	OS-PK-3-6/3
AND block (3 AND gates)		4204	ZK-PK-3-6/3

One-way flow control valves GRF, for mounting frame 2N

Technical data

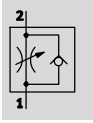
One-way flow control function



-  - Flow rate
45 l/min
-  - Temperature range
-10 ... +60 °C
-  - Operating pressure
0.5 ... 8 bar



General technical data	
Valve function	One-way flow control function
Pneumatic connection 2	PK-3
Pneumatic connection 1	PK-3
Adjusting element	Knurled screw
Type of mounting	With through-hole
Mounting position	Any

Operating and environmental conditions	
Operating pressure [bar]	0.5 ... 8
Operating medium	Compressed air according to ISO 8573-1:2010 [7:-:-]
Note on operating/pilot medium	Lubricated operation possible (in which case lubricated operation will always be required)
Ambient temperature [°C]	-10 ... +60
Temperature of medium [°C]	-10 ... +60

Standard nominal flow rate q_{nN} at 6 > 5 bar as a function of turns of the adjusting screw n

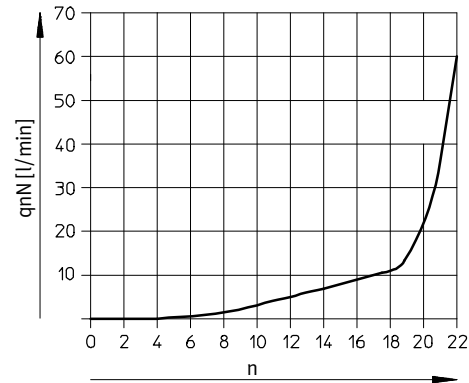

One-way flow control valves GRF, for mounting frame 2N

Technical data

Materials

Sectional view

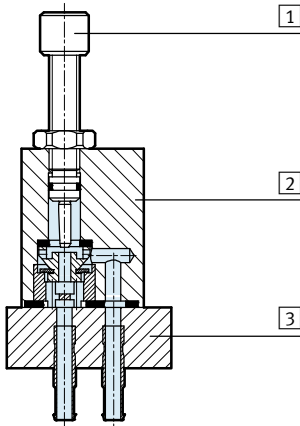

One-way flow control valve

1	Regulating screw	Brass
2	Housing	Wrought aluminium alloy
3	Connecting plate	PA
-	Seals	NBR

Dimensions

Download CAD data → www.festo.com

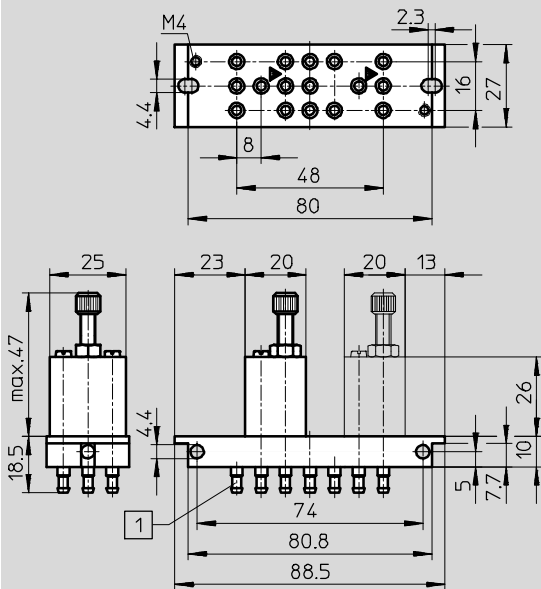

1 Barbed connector PK-3

Ordering data – One-way flow control function

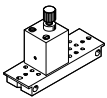
Pneumatic connection	Standard nominal flow rate q _n		Number of one-way flow control valves	Weight [g]	Part No.	Type		
	[l/min] at 6 bar → 5 bar							
2	1	In direction of flow control	In non-return direction					
Knurled screw								
	PK-3	PK-3	45	45	1	95	4565	GRF-PK-3
					2	145	4566	GRF-PK-3X2

PE converters PE/VPE, for mounting frame 2N

FESTO

Technical data

General technical data		
	PE converter PE-1/8-2N-SW	Vacuum switch VPE-1/8-2N-SW
Method of measurement	Pneumatic/electric pressure transducer	
Measured variable	Relative pressure	
Type of mounting	On mounting frame 2N With through-hole	
Mounting position	Any	
Pneumatic connection	G1/8	
Electrical connection	3 connector leads	3 connector leads
Materials		
Housing	Die-cast aluminium, PA, steel	PA, POM, steel, VMQ
Diaphragm	TPE-U(PU)	CR
Switch contact	Silver	Silver
Electrical connection	Tin-plated	Tin-plated
Cable sheath	PVC	–
Weight [g]	65	45

– † – Note: This product conforms to ISO 1179-1 and to ISO 228-1

Operating and environmental conditions		
	PE converter PE-1/8-2N-SW	Vacuum switch VPE-1/8-2N-SW
Operating medium	Compressed air in accordance with ISO 8573-1:2010 [7:4:4]	
Note on operating/pilot medium	Operation with lubricated medium possible (in which case lubricated operation will always be required)	
Operating pressure [bar]	0 ... 8	0 ... –0,95
Switch-on pressure [bar]	2	–0,25
Switch-off pressure [bar]	0,5	≤ 0,1
Ambient temperature [°C]	0 ... +60	
Temperature of medium [°C]	0 ... +60	

Electrical data		
	PE converter PE-1/8-2N-SW	Vacuum switch VPE-1/8-2N-SW
Operating voltage range AC [V AC]	12 ... 250	
Operating voltage range DC [V DC]	12 ... 250	
Switching element function	Changeover contact	
Switching output	Contacting	–
Switching function	Threshold value with fixed hysteresis	–
Minimum load current [mA]	100	
Max. switching frequency [Hz]	1	
CE marking (see declaration of conformity)	To EU Low Voltage Directive	
Approval certificate	CCC	
Degree of protection	IP67	IP67

PE converters PE/VPE, for mounting frame 2N

Technical data

Max. permissible electrical load					
DC voltage			AC voltage		
Voltage [V DC]	Resistance load [A]	Inductive load [A]	Voltage [V AC]	Resistance load [A]	Inductive load [A]
PE/VPE-1/8-2N-SW					
15	10	10	125	5	5
30	5	3	250	5	2
50	1	1			
75	0.75	0.25			
124	0.5	0.03			
250	0.25	0.02			

Pin allocation

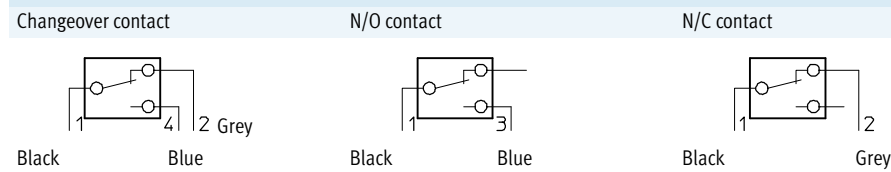

PE converters PE/VPE, for mounting frame 2N

Technical data

Dimensions

Download CAD data → www.festo.com

PE converter

PE-1/8-2N-SW

Splash-proof design

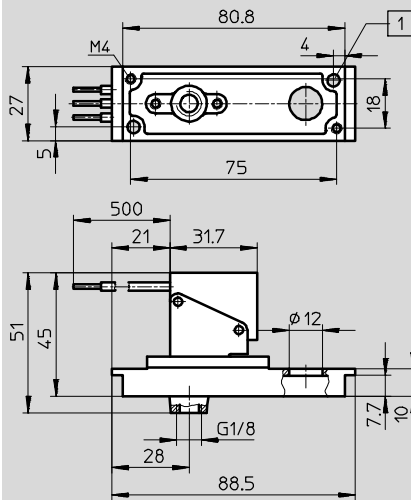

1 For M4 thread

Note: This product conforms to ISO 1179-1 and to ISO 228-1

Vacuum switch

VPE-1/8-2N-SW

Splash-proof design

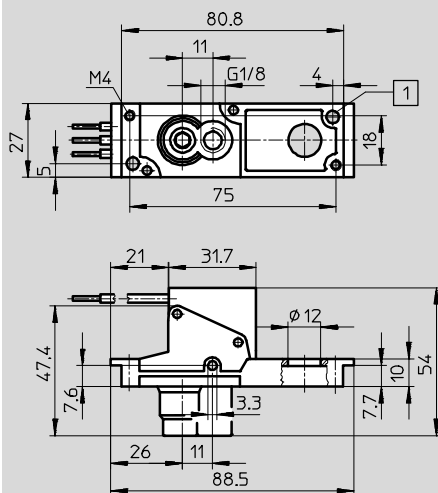

1 For M4 thread

Note: This product conforms to ISO 1179-1 and to ISO 228-1

PE converters PE/VPE, for mounting frame 2N

FESTO

Technical data

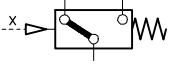
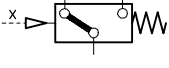
Ordering data		Part No.	Type
PE converter Splash-proof design		7862	PE-1/8-2N-SW
Vacuum switch Splash-proof design		12595	VPE-1/8-2N-SW
Accessories			
Protective cap for protection against accidental contact		165614	SPE-B

PE converters PEN-M5, for mounting frame 2N

FESTO

Technical data

Function



- - Temperature range
-20 ... +60 °C
- - Operating pressure
-1 ... +8 bar



General technical data	
Certification	RCM mark
CE marking (see declaration of conformity)	To EU EMC Directive ¹⁾
Note on materials	RoHS-compliant Free of copper and PTFE

- 1) For information about the applicability of the component see the manufacturer's EC declaration of conformity at: www.festo.com/sp → Certificates.
If the component is subject to restrictions on usage in residential, office or commercial environments or small businesses, further measures to reduce the emitted interference may be necessary.

Input signal/measuring element	
Measured variable	Relative pressure (overpressure: connection to P1/vacuum: connection to P2) Differential pressure (connection P1 and P2, condition: P1 ≥ P2)
Method of measurement	Pneumatic/electrical differential pressure switch
Operating pressure [bar]	-1 ... +8
Operating medium	Compressed air to ISO 8573-1:2010 [7:4:4]
Note on operating/pilot medium	Lubricated operation possible (in which case lubricated operation will always be required)
Temperature of medium [°C]	-20 ... +60
Ambient temperature [°C]	-20 ... +60

Switching output	
Switching output	PNP
Switching element function	N/O contact
Threshold value setting range [bar]	-0.8 ... +8
Max. switching frequency [Hz]	70
Max. output current [mA]	350

Output, additional data	
Protection against short circuit	Yes

Electronics	
Operating voltage range [V DC]	12 ... 30

Electromechanics	
Electrical connection	Cable, 3-wire, open end
Cable length [m]	2.5

Mechanical system	
Type of mounting	On mounting frame 2N With through-hole
Mounting position	Any
Pneumatic connection	M5
Information on housing materials	Die-cast zinc

PE converters PEN-M5, for mounting frame 2N

Technical data

Display/operation	
Switching status indication	Yellow LED

Immission/emission	
Degree of protection	IP67

Hysteresis H as a function of the differential pressure Δp

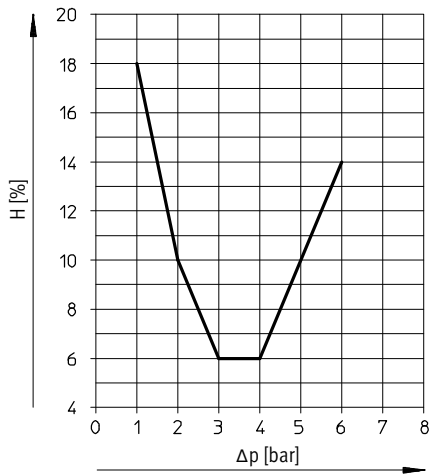

Dimensions Download CAD data → www.festo.com

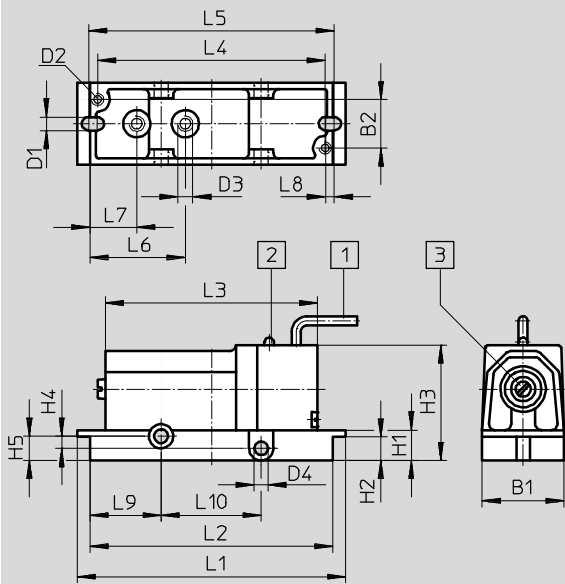

- Colour coding:
 BN = 24 V
 BU = 0 V
 BK = switching output
 The switch is protected against polarity reversal
- 1 Cable: 3 x 0.14 mm², 2.5 m long
 - 2 Yellow LED
 - 3 Pressure threshold setting

B1	B2	D1 Ø	D2	D3	D4 Ø	H1	H2	H3	H4	H5	L1	L2	L3	L4	L5	L6	L7	L8	L9	L10
27	16	4.4	M4	M5	4.5	10	7.7	37	3	8	88.5	80.8	70	75	81	31.4	15.4	2.9	23.4	33

Ordering data						
	Pneumatic connection	Electrical connection	Cable length [m]	Weight [g]	Part No.	Type
	M5	Cable, 3-wire, open end	2.5	240	8625	PEN-M5

Mounting frames 2N

Accessories



Mounting frame NRRQ-2N

Scope of delivery

- 2 x connecting piece NRV-2N
- 2 x mounting rail NRQ-8-480
- 4 x mounting bracket NRW-12/3
- 4 x threaded spacer NRB-12/60
- 4 x slotted head screw
DIN 84-M6X18-4.8
- 4 x slotted head screw
DIN 84-M6X12-4.8
- 4 x mounting bracket NRW-9/1,5-B
- 4 x slotted head screw
DIN 84-M4X10-4.8

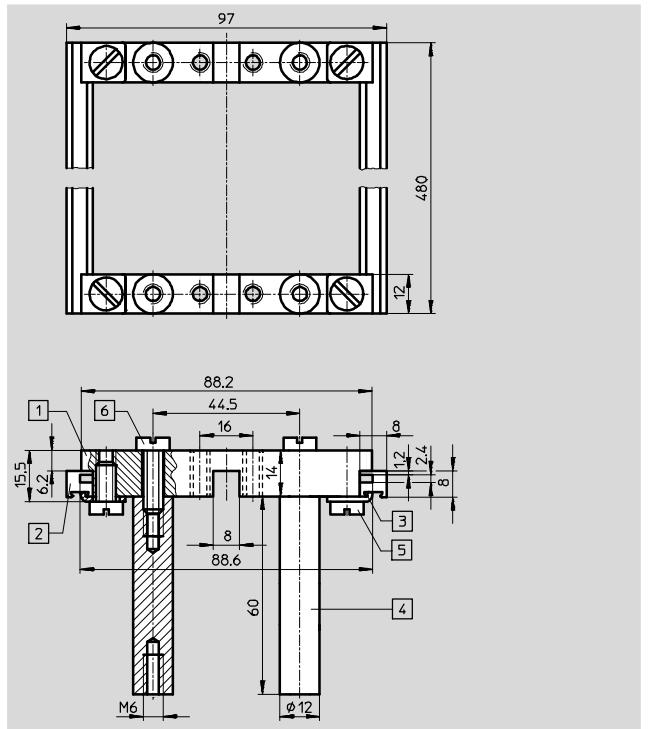

- 1 Connecting piece NRV-2N
- 2 Mounting rail NRQ-8-480
- 3 Mounting bracket NRW-12/3
- 4 Threaded spacer NRB-12/60
- 5 Slotted head screw
DIN 84-M6X18-4.8
- 6 Slotted head screw
DIN 84-M6X12-4.8

Mounting frame	Part No.	Type
Mounting frame 2N complete for 16 components	9365	NRRQ-2N
Accessories		
Mounting bracket for mounting sub-bases on the frame	11571	NRW-9/1,5-B
Slotted head screw (2 included in scope of delivery)	204021	DIN 84-M4X12-4.8

AND/OR gates OS/ZK

Technical data

AND gate ZK

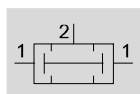

OR gate OS

OS-PK-3

OS-1/8/1/4-B

OS-1/2

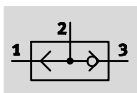
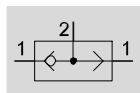

- - Flow rate
120 ... 5000 l/min
- - Temperature range
-10 ... +60 °C
- - Operating pressure
1 ... 10 bar

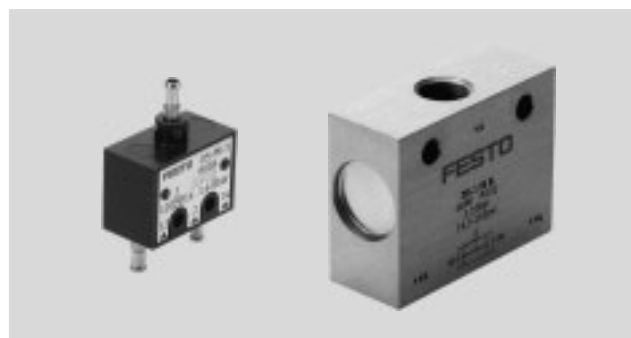

Valve function

AND function

For an AND gate, all input signals must be active at the same time in order to execute a function. The AND gate ZK has two inputs X, Y and one output A. The output A is only pressurised if pressure is supplied to both inputs at the same time. If different pressures are present at the inputs, the lower pressure is fed to output A.

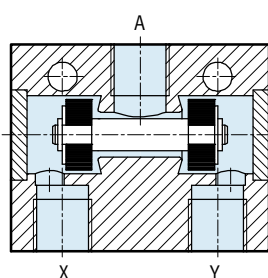

OR function

For an OR gate, at least one of all the input signals must be active in order to execute a function. The OR gate OS has two inputs X, Y and one output A. The output A is pressurised if pressure is supplied to at least one of the two inputs. The valve automatically blocks the input which is not pressurised. If both inputs are simultaneously supplied with different pressures, the higher pressure is fed to output A.

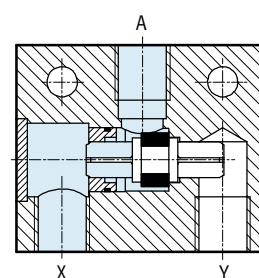

General technical data

Valve function	AND function		OR function			
Type	ZK-PK-3	ZK-1/8-B	OS-PK-3	OS-1/8-B	OS-1/4-B	OS-1/2
Pneumatic connection	PK-3	G1/8	PK-3	G1/8	G1/4	G1/2
Nominal size [mm]	2.4	4.5	2.4	4	6.5	12
Type of mounting	With through-hole					
Mounting position	Any					

- - Note: This product conforms to ISO 1179-1 and to ISO 228-1

Operating and environmental conditions

Type	ZK-PK-3	ZK-1/8-B	OS-PK-3	OS-1/8-B	OS-1/4-B	OS-1/2
Operating pressure [bar]	1.6 ... 8	1 ... 10	1.6 ... 8	1 ... 10	1 ... 10	1 ... 10
Operating/pilot medium	Compressed air to ISO 8573-1:2010 [7:-:-]					
Note on operating/pilot medium	Lubricated operation possible (in which case lubricated operation will always be required)					
Ambient temperature [°C]	-10 ... +60					
Temperature of medium [°C]	-10 ... +60					

Materials

Type	ZK-PK-3	ZK-1/8-B	OS-PK-3	OS-1/8-B	OS-1/4-B	OS-1/2
Housing	Brass, POM	Anodised wrought aluminium alloy	POM	Wrought aluminium alloy		
Seals	NBR					
Note on materials	RoHS-compliant					

AND/OR gates OS/ZK

Technical data

FESTO

Dimensions Download CAD data → www.festo.com

ZK-PK-3	ZK-1/8-B	OS-1/4-B	OS-1/2
OS-PK-3	OS-1/8-B		

1 Barbed connector PK-3

Note: This product conforms to ISO 1179-1 and to ISO 228-1

Ordering data					
Valve function	Pneumatic connection 1, 2, 3	Standard nominal flow rate qnN [l/min]	Weight [g]	Part No.	Type
AND function	PK-3	120	10	6685	ZK-PK-3
	G1/8	550	45	6680	ZK-1/8-B
OR function	PK-3	120	9	6684	OS-PK-3
	G1/8	500	45	6681	OS-1/8-B
	G1/4	1170	110	6682	OS-1/4-B
	G1/2	5000	814	3427	OS-1/2

Counters PZA/PZV

Key features

FESTO



Adding counter

- Surface mounting
- Panel mounting

Adding counters have 6-digit displays and count upwards, i.e. incoming signals are added. When the counter is reset, 000 000 appears.

A pneumatic signal increments the counter by a half step, and the first half of the digit appears. After completion of the signal, the second half-step increment occurs and the digit becomes fully visible.

The counter can be reset manually by means of a button. It can also be reset by means of a pneumatic signal. A counting signal may not arrive or be present during the resetting procedure.

Predetermining counter

- Subtracting counting mode
- Manual and pneumatic reset
- Protective cover

Predetermining counters count pneumatic signals backwards from a preset number. When zero is reached, the counter generates a pneumatic output signal. This output signal persists until the counter is reset. The counter is preset by pressing the reset button and simultaneously keying in the preset value. This value is retained when the counter is reset.

Counters PZA/PZV

Technical data

General technical data			
Type	Adding counter		Predetermining counter
	PZA-A-B	PZA-E-C	PZV-E-C
Constructional design	Mechanical counter with pneumatic drive		
Type of mounting	3 through-holes in housing	Panel mounting	
Operating medium	Compressed air in accordance with ISO 8573-1:2010 [7:4:4]		
Note on operating/pilot medium	Operation with lubricated medium not possible		
Pneumatic connection			
Display ¹⁾	6-digit	6-digit	5-digit
Reset	Pushbutton or pneumatic signal		
Response pressure			
Drive	[bar]	0.6 ±0.2	> 0.8
Reset	[bar]	0.6 ±0.2	2
Drop-off pressure			
Drive	[bar]	0.2 ±0.1	< 0.15
Reset	[bar]	0.15 ±0.1	< 0.15
Min. pulse length			
Drive	[ms]	10	8
Reset	[ms]	180	150
Min. pause period			
Drive	[ms]	15	10
Reset	[ms]	50	50
Materials			
	Housing: Plastic		
	Seals: Chloroprene		
Weight	[g]	155	70
			150

1) Digit size 4.5 mm

Operating and environmental conditions			
Type	Adding counter		Predetermining counter
	PZA-A-B	PZA-E-C	PZV-E-C
Operating pressure	[bar]	2 ... 8	
Min. reset pressure	[bar]	2	–
Ambient temperature	[°C]	–10 ... +60	0 ... +60

Counters PZA/PZV

Technical data

Counting rate

Adding counter PZA-E-C

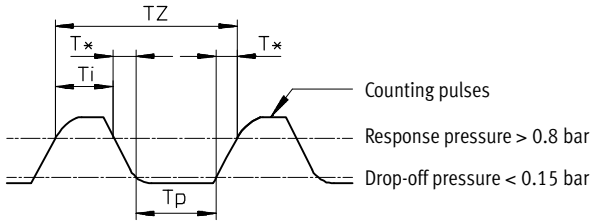

$$\text{Max. pulse rate} = \frac{1}{T_z}$$

$$T_z = T_i + T_p + T^*$$

$$T_z = T_i + T^*$$

T_i = Min. pulse length

T_p = Min. pause period

T_z = Time for counting pulse

T^* = Depends on pressure and tubing length (values must be determined empirically)

Counting speed v as a function of the operating pressure p

Predetermining counter PZV-E-C

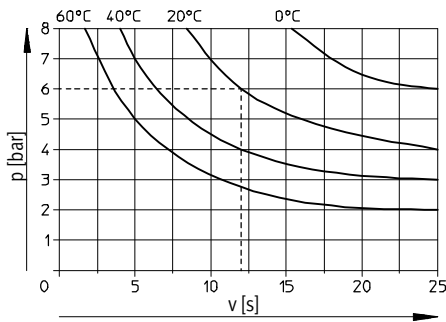

Intermittent operation

The counter operates non-continuously. The counting rate is constant right down to zero contact (high rate possible). A reset then follows.

Continuous operation

The counter operates continuously at a constant rate. The interval between 2 counting signals is longer than the required reset time.

Counters PZA/PZV

Technical data

Dimensions

Download CAD data → www.festo.com

Adding counter

Surface mounting PZA-A-B

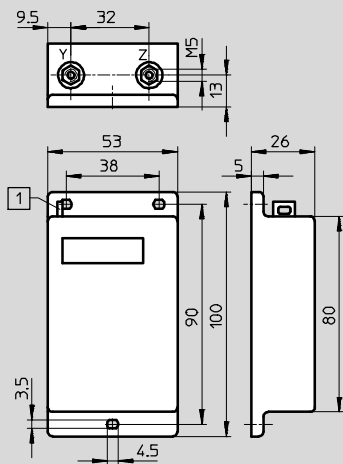

1 Reset button

Z = Counting signal

Y = Reset signal

Panel mounting PZA-E-C

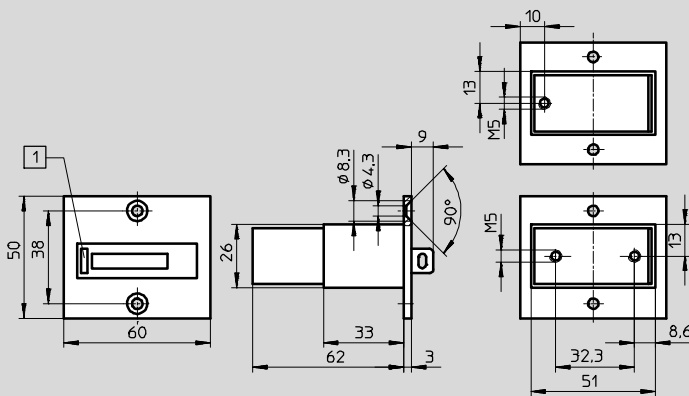

1 Reset button

Predetermining counter

Surface mounting PZV-E-C

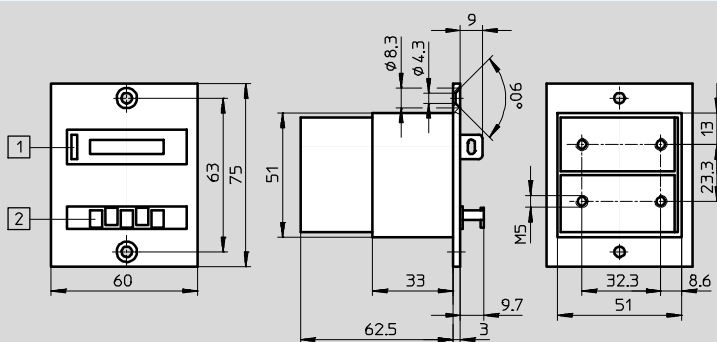

1 Reset button

2 Preselect buttons

The preset number is restored using the reset button or by a pneumatic signal to the reset port.



The output signal must not be used to reset the counter. No counting signal may arrive or be present during the resetting procedure.

Counters PZA/PZV

Technical data

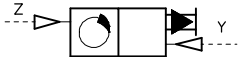
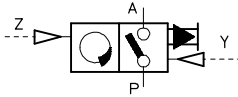
Ordering data			Part No.	Type
Adding counter	Surface mounting		14992	PZA-A-B
	Panel mounting		8606	PZA-E-C
Predetermining counter	Surface mounting		15608	PZV-E-C

Counters PZA/PZV

Accessories

FESTO

Protective cover with rotary knob PZ-SK-1 with lock PZ-SS-1

Protective cover for adding counter to protect against entry of dirt and water on the front panel

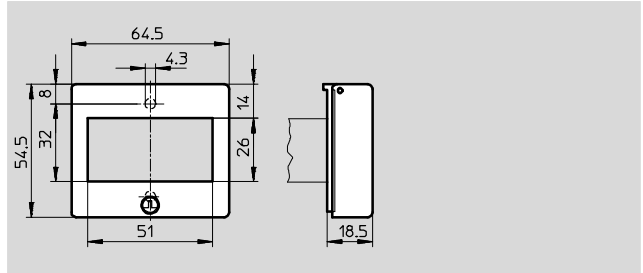
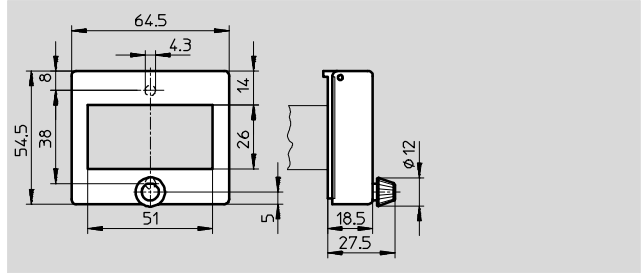
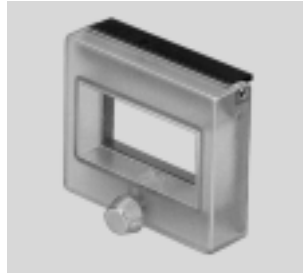

Ordering data		
	Part No.	Type
Protective cover with rotary knob	14662	PZ-SK-1
Protective cover with lock	13965	PZ-SS-1

Protective cover with rotary knob PZ-SK-2 with lock PZ-SS-2

Protective cover for predetermining counter to protect against entry of dirt and water on the front panel

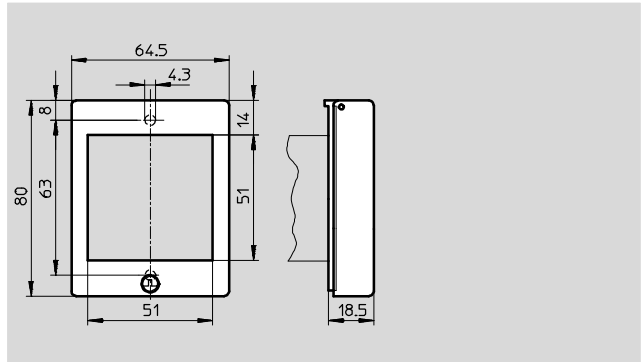
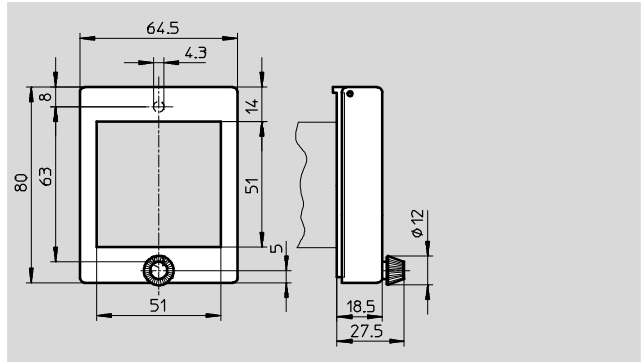

Ordering data		
	Part No.	Type
Protective cover with rotary knob	14663	PZ-SK-2
Protective cover with lock	13966	PZ-SS-2

Timers PZVT

Key features

FESTO

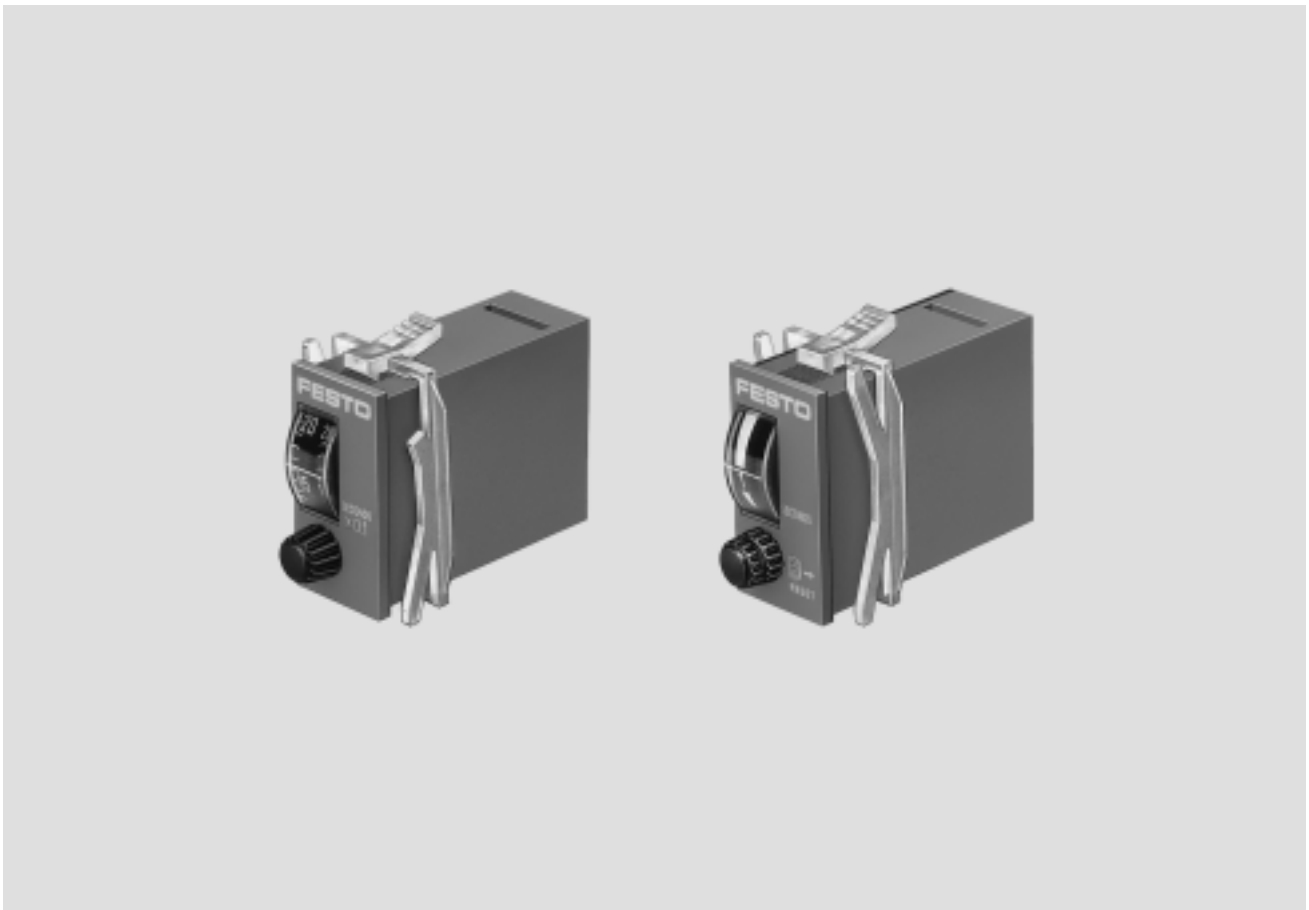

		Pneumatic timer PZVT	Automatic reset module PZVT-AUT
<ul style="list-style-type: none">• Adjustable delay times<ul style="list-style-type: none">– 0.2 ... 3 s– 2 ... 30 s– 8 ... 120 s– 20 ... 300 s	<ul style="list-style-type: none">• Panel mounting• Mounting on H-rail to EN 60715• Protective cover	<p>The timer switches input pressure applied to port 1 through to port 2 after the preset delay time has expired.</p>	<p>The reset module is used to automatically reset timers of type PZVT-...-SEC at the end of a preset time and to generate an output signal of defined duration for control system purposes. The timer can be reset manually by pulling the setting knob on the reset module. This allows the simple creation of pneumatic timer controls with automatically repeating time intervals.</p>

Timers PZVT

Technical data

FESTO

General technical data					
Type	Timer				Reset module
	PZVT-3-SEC	PZVT-30-SEC	PZVT-120-SEC	PZVT-300-SEC	PZVT-AUT
Constructional design	Mechanical sequence counter with pneumatic drive				
Type of mounting	Panel mounting				
Operating medium	Compressed air in accordance with ISO 8573-1:2010 [7:4:4]				
Note on operating/pilot medium	Operation with lubricated medium not possible				
Pneumatic connection	Female thread M5				
Standard nominal flow rate [l/min]	50				
Adjustable delay times [s]	0.2 ... 3	2 ... 30	8 ... 120	20 ... 300	0.2 ... 2
Repetition accuracy [s]	±0.1	±0.3	±1.2	±3	±0.3
Setting accuracy [s]	±0.3	±0.6	±3	±6	–
Pause period for reset [ms]	≥ 200				
Protection class	IP54 to IEC 60529 with protective cover and panel frame				
Weight [g]	45				50
Material of housing	ABS				
Note on materials	RoHS-compliant				

Operating and environmental conditions					
Type	PZVT-3-SEC	PZVT-30-SEC	PZVT-120-SEC	PZVT-300-SEC	PZVT-AUT
Operating pressure [bar]	2 ... 6				
Switch-on pressure [bar]	≥ 1.6				
Switch-off pressure [bar]	≤ 0.1				
Ambient temperature [°C]	–10 ... +60				–15 ... +60

Example of application

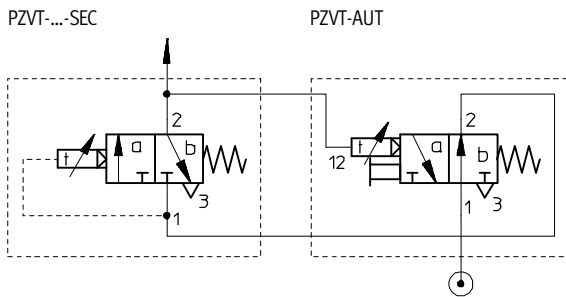

- 1 = Supply port
- 2 = Working or outlet line
- 3 = Exhausts
- 12 = Pilot line

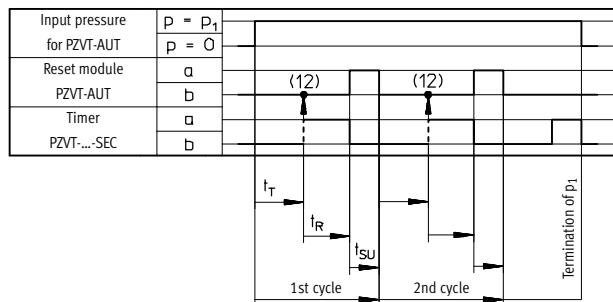

- t_T = Time preset range for timer type PZVT-...-SEC
- t_R = Switching delay time for reset module PZVT-AUT (0.2 ... 2 s)
- t_{SU} = Signal interruption period for reset module PZVT-AUT (≥ 300 ms)

Dimensions

Download CAD data → www.festo.com

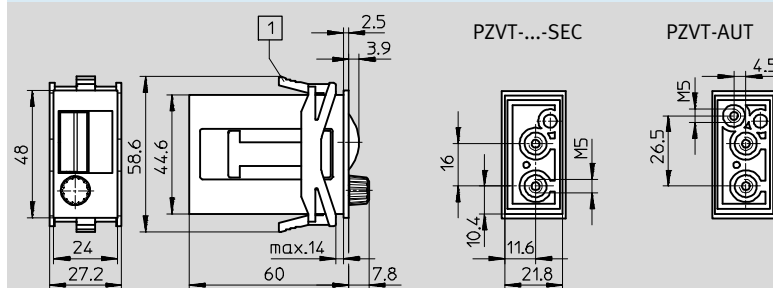

- 1 Clamping frame included in scope of delivery

Timers PZVT

Technical data

Ordering data			Part No.	Type
Timer	0.2 ... 3 s		158495	PZVT-3-SEC
	2 ... 30 s		150238	PZVT-30-SEC
	8 ... 120 s		177616	PZVT-120-SEC
	20 ... 300 s		150239	PZVT-300-SEC
Reset module	0.2 ... 2 s		158496	PZVT-AUT

Timers PZVT

Accessories

FESTO

Protective cover with rotary knob PZ-SK-2 with lock PZ-SS-2

Protective cover for timers to protect
against entry of dirt and water on the
front panel

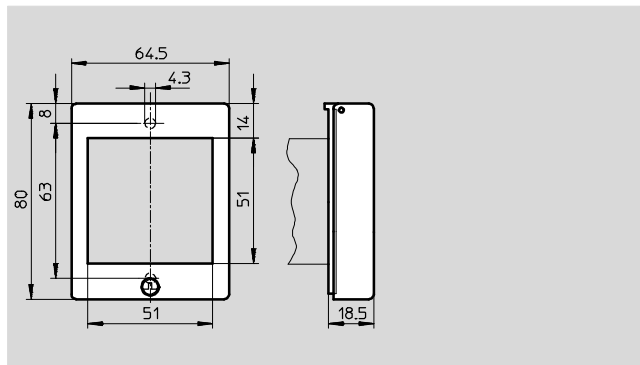
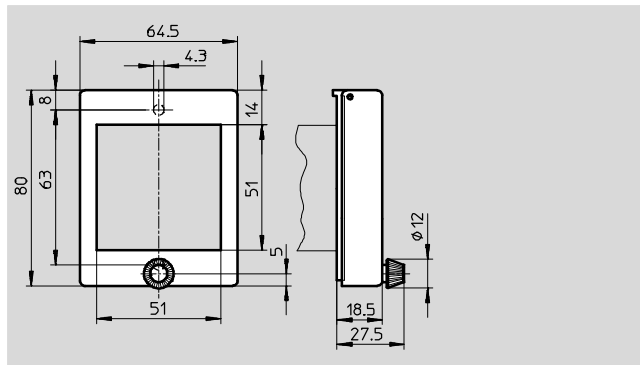

Ordering data		
	Part No.	Type
Protective cover with rotary knob	14663	PZ-SK-2
Protective cover with lock	13966	PZ-SS-2

Panel frame PZVT-FR for panel mounting

Note on materials: RoHS-compliant

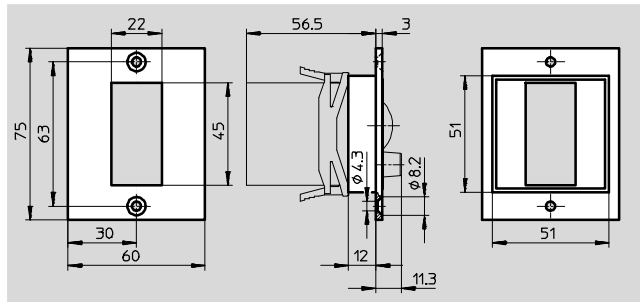

Ordering data		
	Part No.	Type
Panel frame	150241	PZVT-FR

Timers PZVT

Accessories

Base PZVT-S-DIN

for mounting on H-rail to EN 60715

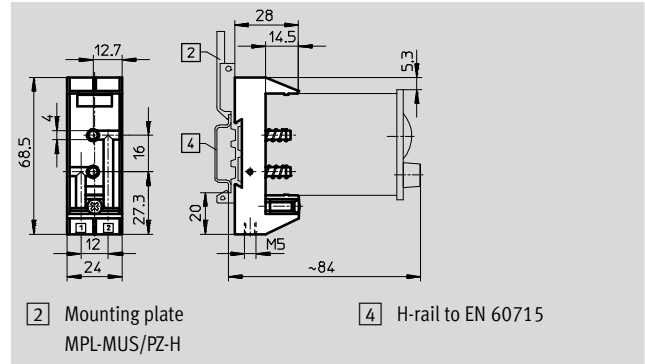

 Note
The base PZVT-S-DIN cannot be used for the reset module PZVT-AUT.

Ordering data		
	Part No.	Type
Base	150240	PZVT-S-DIN

Mounting plate MPL-MUS/PZ-H

for H-rail to EN 60715



Ordering data		
	Part No.	Type
Mounting plate for H-rail	19135	MPL-MUS/PZ-H