





# Service unit combinations FRC-K, D series



# Service unit combinations FRC-K, D series, metal design

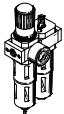

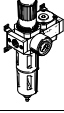
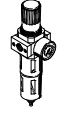
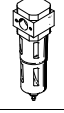
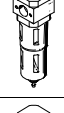
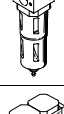
Product range overview D series service units, metal design

Type	Size	Pneumatic connection										Pressure regulation range [bar]			Grade of filtration [µm]			
		M5	M7	G1/8	G1/4	G3/8	G1/2	G3/4	G1	QS4	QS6	0.5 ...	0.5 ...	2.5 ...	0.01	1	5	40
<b>Service units</b>																		
<b>FRC/FRCS</b> 	Micro	■	■	■	-	-	-	-	-	■	■	■	-	-	-	-	■	-
	Mini	-	-	■	■	■	-	-	-	-	-	■	■	-	-	-	■	■
	Midi	-	-	-	■	■	■	■	-	-	-	■	■	-	-	-	■	■
	Maxi	-	-	-	-	-	■	■	■	-	-	■	■	-	-	-	■	■
<b>Service unit combinations</b>																		
<b>FRC-K</b> 	Micro	-	-	-	-	-	-	-	-	-	-	-	-	-	-	-	-	
	Mini	-	-	■	■	-	-	-	-	-	-	■	■	-	-	-	-	■
	Midi	-	-	-	■	■	■	■	-	-	-	■	■	-	-	-	-	■
	Maxi	-	-	-	-	-	■	■	-	-	-	■	■	-	-	-	-	■
<b>LFR-K LFRS-K</b> 	Micro	-	-	-	-	-	-	-	-	-	-	-	-	-	-	-	-	
	Mini	-	-	■	■	-	-	-	-	-	-	■	■	-	-	-	-	■
	Midi	-	-	-	■	■	■	■	-	-	-	■	■	-	-	-	-	■
	Maxi	-	-	-	-	-	■	■	-	-	-	■	■	-	-	-	-	■
<b>Individual devices</b>																		
<b>Filter regulators LFR/LFRS</b> 	Micro	■	■	■	-	-	-	-	-	■	■	■	-	-	-	-	■	-
	Mini	-	-	■	■	■	-	-	-	-	-	■	■	-	-	-	■	■
	Midi	-	-	-	■	■	■	■	-	-	-	■	■	-	-	-	■	■
	Maxi	-	-	-	-	-	■	■	■	-	-	■	■	-	-	-	■	■
<b>Filters LF</b> 	Micro	■	■	■	-	-	-	-	-	■	■	-	-	-	-	-	■	-
	Mini	-	-	■	■	■	-	-	-	-	-	-	-	-	-	-	■	■
	Midi	-	-	-	■	■	■	■	-	-	-	-	-	-	-	-	■	■
	Maxi	-	-	-	-	-	■	■	■	-	-	-	-	-	-	-	■	■
<b>Fine and micro filters LFMA/LFMB</b> 	Micro	-	-	-	-	-	-	-	-	-	-	-	-	-	-	-	-	
	Mini	-	-	■	■	■	-	-	-	-	-	-	-	■	■	-	-	-
	Midi	-	-	-	■	■	■	■	-	-	-	-	-	■	■	-	-	-
	Maxi	-	-	-	-	-	■	■	■	-	-	-	-	■	■	-	-	-
<b>Active carbon filters LFX</b> 	Micro	-	-	-	-	-	-	-	-	-	-	-	-	-	-	-	-	
	Mini	-	-	■	■	■	-	-	-	-	-	-	-	-	-	-	-	-
	Midi	-	-	-	■	■	■	■	-	-	-	-	-	-	-	-	-	-
	Maxi	-	-	-	-	-	■	■	■	-	-	-	-	-	-	-	-	-
<b>Filter combinations LFMBA</b> 	Micro	-	-	-	-	-	-	-	-	-	-	-	-	-	-	-	-	
	Mini	-	-	■	■	■	-	-	-	-	-	-	-	■	■	-	-	-
	Midi	-	-	-	■	■	■	■	-	-	-	-	-	■	■	-	-	-
	Maxi	-	-	-	-	-	■	■	■	-	-	-	-	■	■	-	-	-
<b>Pressure regulators LR/LRS</b> 	Micro	■	■	■	-	-	-	-	-	■	■	■	-	-	-	-	-	-
	Mini	-	-	■	■	■	-	-	-	-	-	■	■	-	-	-	-	-
	Midi	-	-	-	■	■	■	■	-	-	-	■	■	-	-	-	-	-
	Maxi	-	-	-	-	-	■	■	■	-	-	■	■	-	-	-	-	-

# Service unit combinations FRC-K, D series, metal design

Product range overview D series service units, metal design

Type	Size	Bowl guard		Condensate drain			Pressure indication		Actuator lock		Supply voltage			Options			→ Page/ Internet
		Metal bowl guard	Plastic bowl	Manual rotary	Semi-automatic	Fully automatic	With pressure gauge	Without pressure gauge	Rotary knob with detent	Rotary knob with integrated lock	24 V DC	110 V AC	230 V AC	Directly actuated pressure regulator with integrated return flow function	Pilot actuated pressure regulator with integrated return flow function	Differential pressure indicator	
<b>Service units</b>																	
FRC/FRCS	Micro	-	■	■	■	-	■	■	■	-	-	-	-	-	-	-	frc
	Mini	■	-	■	-	■	■	■	■	■	-	-	-	-	-	-	
	Midi	■	-	■	-	■	■	■	■	■	-	-	-	-	-	-	
	Maxi	■	-	■	-	■	■	■	■	■	-	-	-	■	■	-	
<b>Service unit combinations</b>																	
FRC-K	Micro	-	-	-	-	-	-	-	-	-	-	-	-	-	-	-	6
	Mini	■	-	■	-	■	■	-	■	-	■	-	-	-	-	-	
	Midi	■	-	■	-	■	■	-	■	-	■	-	-	-	-	-	
	Maxi	■	-	■	-	■	■	-	■	-	■	-	-	■	■	-	
LFR-K LFRS-K	Micro	-	-	-	-	-	-	-	-	-	-	-	-	-	-	-	lfr
	Mini	■	-	■	-	■	■	-	■	■	■	-	-	-	-	-	
	Midi	■	-	■	-	■	■	-	■	■	■	-	-	-	-	-	
	Maxi	■	-	■	-	■	■	-	■	■	■	-	-	■	■	-	
<b>Individual devices</b>																	
Filter regulators LFR/LFRS	Micro	-	■	■	■	-	■	■	■	-	-	-	-	-	-	-	lfr
	Mini	■	-	■	-	■	■	■	■	■	-	-	-	-	-	-	
	Midi	■	-	■	-	■	■	■	■	■	-	-	-	-	-	-	
	Maxi	■	-	■	-	■	■	■	■	■	-	-	-	■	■	-	
Filters LF	Micro	-	■	■	■	-	-	-	-	-	-	-	-	-	-	-	lf
	Mini	■	-	■	-	■	-	-	-	-	-	-	-	-	-	-	
	Midi	■	-	■	-	■	-	-	-	-	-	-	-	-	-	-	
	Maxi	■	-	■	-	■	-	-	-	-	-	-	-	-	-	-	
Fine and micro filters LFMA/LFMB	Micro	-	-	-	-	-	-	-	-	-	-	-	-	-	-	-	lfma, lfmb
	Mini	■	-	■	-	■	-	-	-	-	-	-	-	-	-	■	
	Midi	■	-	■	-	■	-	-	-	-	-	-	-	-	-	■	
	Maxi	■	-	■	-	■	-	-	-	-	-	-	-	-	-	■	
Active carbon filters LFX	Micro	-	-	-	-	-	-	-	-	-	-	-	-	-	-	-	lfx
	Mini	■	-	-	-	-	-	-	-	-	-	-	-	-	-	-	
	Midi	■	-	-	-	-	-	-	-	-	-	-	-	-	-	-	
	Maxi	■	-	-	-	-	-	-	-	-	-	-	-	-	-	-	
Filter combinations LFMBA	Micro	-	-	-	-	-	-	-	-	-	-	-	-	-	-	-	lfmba
	Mini	■	-	■	-	■	-	-	-	-	-	-	-	-	-	■	
	Midi	■	-	■	-	■	-	-	-	-	-	-	-	-	-	■	
	Maxi	■	-	■	-	■	-	-	-	-	-	-	-	-	-	■	
Pressure regulators LR/LRS	Micro	-	-	-	-	-	■	■	■	-	-	-	-	-	-	-	lr
	Mini	-	-	-	-	-	■	■	■	■	-	-	-	■	-	-	
	Midi	-	-	-	-	-	■	■	■	■	-	-	-	■	-	-	
	Maxi	-	-	-	-	-	■	■	■	■	-	-	-	■	■	-	

# Service unit combinations FRC-K, D series, metal design



Product range overview D series service units, metal design

Type	Size	Pneumatic connection										Pressure regulation range [bar]			
		M5	M7	G1/8	G1/4	G3/8	G1/2	G3/4	G1	QS4	QS6	0.5 ... 7	0.5 ... 12		
<b>Individual devices</b>															
Pressure regulators <b>LRB/LRBS</b>		Micro	-												
		Mini	-	-	-	■	-	-	-	-	-	-	-	■	■
		Midi	-	-	-	-	■	-	-	-	-	-	-	■	■
		Maxi	-												
Pressure regulator combinations <b>LRB-K</b>		Micro	-												
		Mini	-	-	-	■	■	-	-	-	-	-	-	■	■
		Midi	-	-	-	-	■	■	-	-	-	-	-	■	■
		Maxi	-												
Lubricators <b>LOE</b>		Micro	■	■	■	-	-	-	-	-	■	■	-	-	
		Mini	-	-	■	■	■	-	-	-	-	-	-	-	
		Midi	-	-	-	■	■	■	■	-	-	-	-	-	
		Maxi	-	-	-	-	-	■	■	■	-	-	-	-	
On-off valves <b>HE</b>		Micro	-												
		Mini	-	-	■	■	■	-	-	-	-	-	-	-	
		Midi	-	-	-	■	■	■	■	-	-	-	-	-	
		Maxi	-	-	-	-	-	■	■	■	-	-	-	-	
On-off valves, electrical <b>HEE</b>		Micro	-												
		Mini	-	-	■	■	■	-	-	-	-	-	-	-	
		Midi	-	-	-	■	■	■	■	-	-	-	-	-	
		Maxi	-	-	-	-	-	■	■	■	-	-	-	-	
On-off valves, pneumatic <b>HEP</b>		Micro	-												
		Mini	-	-	■	■	■	-	-	-	-	-	-	-	
		Midi	-	-	-	■	■	■	■	-	-	-	-	-	
		Maxi	-	-	-	-	-	■	■	■	-	-	-	-	
Soft-start valves <b>HEL</b>		Micro	-												
		Mini	-	-	■	■	■	-	-	-	-	-	-	-	
		Midi	-	-	-	■	■	■	■	-	-	-	-	-	
		Maxi	-	-	-	-	-	■	■	■	-	-	-	-	
Membrane air dryers <b>LDM1</b>		Micro	-												
		Mini	-												
		Midi	-												
		Maxi	-	-	-	-	-	■	■	■	-	-	-	-	
Branching modules <b>FRM</b>		Micro	-												
		Mini	-	-	■	■	■	-	-	-	-	-	-	-	
		Midi	-	-	-	■	■	■	■	-	-	-	-	-	
		Maxi	-	-	-	-	-	■	■	■	-	-	-	-	
Distributor block <b>FRZ</b>		Micro	-												
		Mini	-	-	-	-	-	-	-	-	-	-	-	-	
		Midi	-	-	-	-	-	-	-	-	-	-	-	-	
		Maxi	-	-	-	-	-	-	-	-	-	-	-	-	

# Service unit combinations FRC-K, D series, metal design

Product range overview D series service units, metal design

Type	Size	Bowl guard		Pressure indication		Actuator lock		Supply voltage			Options		→ Page/ Internet
		Metal bowl guard	Plastic bowl	With pressure gauge	Without pressure gauge	Rotary knob with detent	Rotary knob with integrated lock	24 V DC	110 V AC	230 V AC	Non-return function	Pressure switch	
<b>Individual devices</b>													
Pressure regulators <b>LRB/LRBS</b>	Micro	-	-	-	■	■	■	-	-	-	-	-	lrb
	Mini	-	-	-	■	■	■	-	-	-	-	-	
	Midi	-	-	-	■	■	■	-	-	-	-	-	
	Maxi	-	-	-	■	■	■	-	-	-	-	-	
Pressure regulator combinations <b>LRB-K</b>	Micro	-	-	-	■	■	-	-	-	-	-	-	lrb
	Mini	-	-	-	■	■	-	-	-	-	-	-	
	Midi	-	-	-	■	■	-	-	-	-	-	-	
	Maxi	-	-	-	■	■	-	-	-	-	-	-	
Lubricators <b>LOE</b>	Micro	-	■	-	■	-	-	-	-	-	-	-	loe
	Mini	■	-	-	■	-	-	-	-	-	-	-	
	Midi	■	-	-	■	-	-	-	-	-	-	-	
	Maxi	■	-	-	■	-	-	-	-	-	-	-	
On-off valves <b>HE</b>	Micro	-	-	-	■	■	-	-	-	-	-	-	he
	Mini	-	-	-	■	■	-	-	-	-	-	-	
	Midi	-	-	-	■	■	-	-	-	-	-	-	
	Maxi	-	-	-	■	■	-	-	-	-	-	-	
On-off valves, electrical <b>HEE</b>	Micro	-	-	-	■	-	-	■	■	■	-	-	hee
	Mini	-	-	-	■	-	-	■	■	■	-	-	
	Midi	-	-	-	■	-	-	■	■	■	-	-	
	Maxi	-	-	-	■	-	-	■	■	■	-	-	
On-off valves, pneumatic <b>HEP</b>	Micro	-	-	-	■	-	-	-	-	-	-	-	hep
	Mini	-	-	-	■	-	-	-	-	-	-	-	
	Midi	-	-	-	■	-	-	-	-	-	-	-	
	Maxi	-	-	-	■	-	-	-	-	-	-	-	
Soft-start valves <b>HEL</b>	Micro	-	-	-	■	-	-	-	-	-	-	-	hel
	Mini	-	-	-	■	-	-	-	-	-	-	-	
	Midi	-	-	-	■	-	-	-	-	-	-	-	
	Maxi	-	-	-	■	-	-	-	-	-	-	-	
Membrane air dryers <b>LDM1</b>	Micro	-	-	-	■	-	-	-	-	-	-	-	ldm1
	Mini	-	-	-	■	-	-	-	-	-	-	-	
	Midi	-	-	-	■	-	-	-	-	-	-	-	
	Maxi	■	-	-	■	-	-	-	-	-	-	-	
Branching modules <b>FRM</b>	Micro	-	-	-	■	-	-	-	-	-	■	■	frm
	Mini	-	-	-	■	-	-	-	-	-	■	■	
	Midi	-	-	-	■	-	-	-	-	-	■	■	
	Maxi	-	-	-	■	-	-	-	-	-	■	■	
Distributor block <b>FRZ</b>	Micro	-	-	-	■	-	-	-	-	-	-	-	frz
	Mini	-	-	-	■	-	-	-	-	-	-	-	
	Midi	-	-	-	■	-	-	-	-	-	-	-	
	Maxi	-	-	-	■	-	-	-	-	-	-	-	

# Service unit combinations FRC-K, D series, metal design

Product range overview

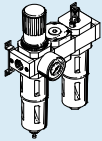
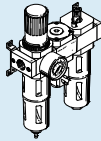
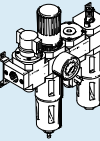
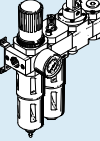
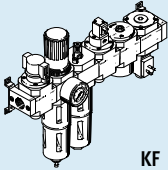
<b>FRC</b> Rotary knob with detent	 KA	 KB	 KC	 KE	 KF
<b>Individual devices</b>					
On-off valve manually actuated	-	-	■	-	■
Filter regulator with pressure gauge	■	■	■	■	■
Branching module	■	-	-	-	-
Branching module with pressure switch	-	■	■	-	■
Lubricator	■	■	■	■	■
On-off valve solenoid actuated, 24 V DC	-	-	-	■	■
Soft-start valve pneumatically actuated	-	-	-	■	■
Mounting bracket	■	■	■	■	■
➔ Page/Internet	9	12	15	18	21

# Service unit combinations FRC-K, D series, metal design

Peripherals overview

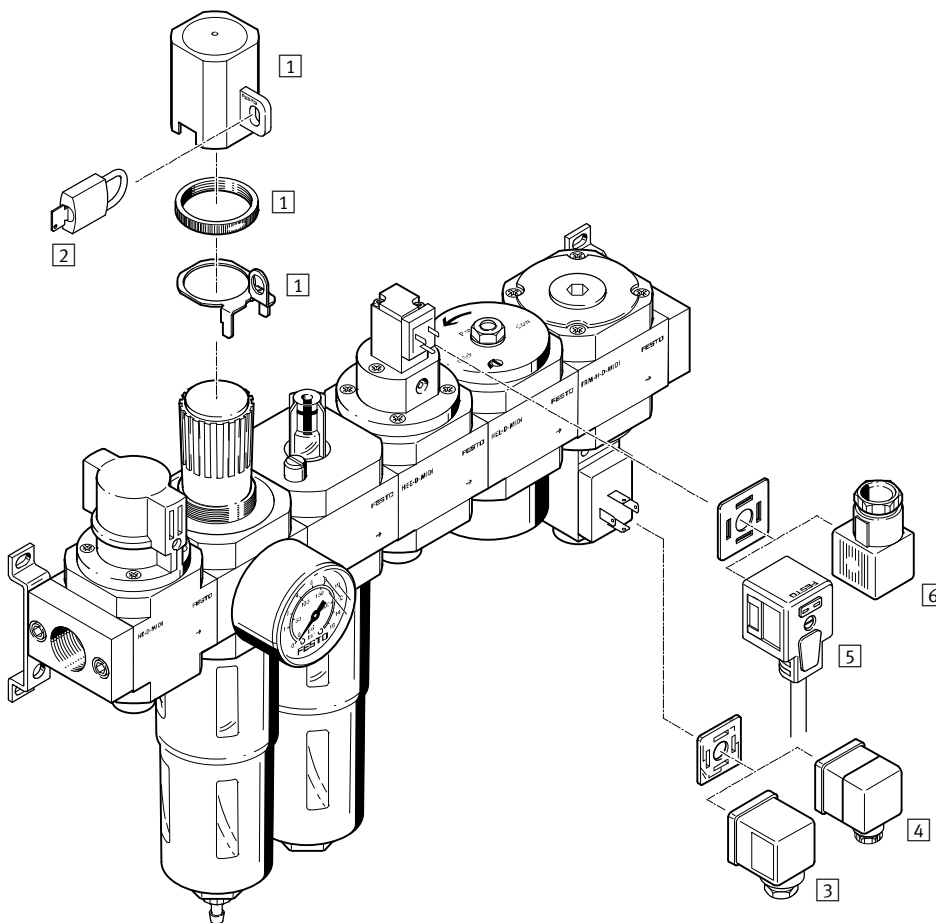

-  - Note

The choice of accessories depends on the selected service unit combination. The example shows the service unit combination FRC-KF.

Range of accessories  
 → Peripherals pages of the individual devices

Mounting attachments and accessories		→ Page/ Internet
1	Regulator lock LRVS	lrvs-d
2	Padlock LRVS	lrvs-d
3	Plug socket MSSD-C	35
4	Angled plug socket PEV-...-WD-LED	35
5	Plug socket with cable KMEB-1	35
6	Plug socket MSSD-EB	35
-	Filter cartridge LFP	34
-	Special oil OFSW	34

# Service unit combinations FRC-K, D series, metal design

Type codes

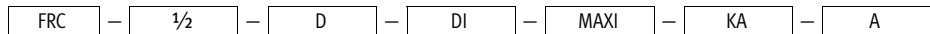

**Basic function**

FRC	Service unit combination
-----	--------------------------

**Pneumatic connection**

1/8	Thread G1/8
1/4	Thread G1/4
3/8	Thread G3/8
1/2	Thread G1/2
3/4	Thread G3/4

**Series**

D	Series
---	--------

**Function (Maxi size only)**

DI	Directly actuated pressure regulator with integrated return flow function
----	---

**Size**

MINI	Grid dimension for individual device 40 mm (without connecting plates)
MIDI	Grid dimension for individual device 55 mm (without connecting plates)
MAXI	Grid dimension for individual device 66 mm (without connecting plates)

**Options for service unit combinations**

KA	Filter regulator, branching module and lubricator
KB	Filter regulator, branching module with pressure switch and lubricator
KC	On-off valve manually actuated, filter regulator, branching module with pressure switch and lubricator
KE	Filter regulator, lubricator, on-off valve solenoid actuated, 24 V DC, soft-start valve pneumatically actuated
KF	On-off valve manually actuated, filter regulator, lubricator, on-off valve solenoid actuated, 24 V DC, soft-start valve pneumatically actuated, branching module with pressure switch

**Condensate drain**

	Manual rotary
A	Fully automatic



# Service unit combinations FRC-KA, D series, metal design

Technical data combination FRC-KA

**Function**

With condensate drain  
manual rotary

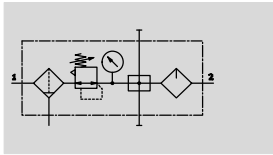

With condensate drain  
fully automatic

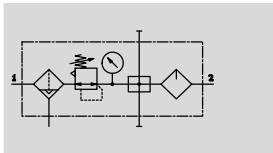

- Filter regulator LFR
- Branching module FRM
- Lubricator LOE
- Mounting accessories

- Flow rate  
650 ... 8,200 l/min
- Temperature range  
-10 ... +60 °C
- Operating pressure  
1 ... 16 bar



- For lubricated and unlubricated compressed air
- Two connections for unlubricated compressed air supply
- One connection for lubricated compressed air supply
- New filter cartridges → 34

General technical data							
Size	Mini		Midi			Maxi	
Pneumatic connection 1, 2	G <sup>1</sup> / <sub>8</sub>	G <sup>1</sup> / <sub>4</sub>	G <sup>1</sup> / <sub>4</sub>	G <sup>3</sup> / <sub>8</sub>	G <sup>1</sup> / <sub>2</sub>	G <sup>1</sup> / <sub>2</sub>	G <sup>3</sup> / <sub>4</sub>
Type of mounting	Via accessories						
	In-line installation						
Assembly position	Vertical ±5°						
Grade of filtration [µm]	40						
Air purity class at the output	Compressed air in accordance with ISO 8573-1:2010 [7:4:-]						
	Inert gases						
Bowl guard	Metal bowl guard						
Condensate drain	Manual rotary						
	Fully automatic						
Actuator lock	Rotary knob with detent						
Pressure regulation range [bar]	0.5 ... 12						
Max. hysteresis [bar]	0.15	0.2	0.25	0.2	0.3	0.1	0.2
Pressure indication	Via pressure gauge						
Max. condensate volume [cm <sup>3</sup> ]	22		43			80 (43) <sup>1)</sup>	

1) For the FRC-...D-DI.

- Note: This product conforms to ISO 1179-1 and to ISO 228-1

Standard nominal flow rate q <sub>N</sub> <sup>1)</sup> [l/min]							
Connection	Mini		Midi			Maxi	
	G <sup>1</sup> / <sub>8</sub>	G <sup>1</sup> / <sub>4</sub>	G <sup>1</sup> / <sub>4</sub>	G <sup>3</sup> / <sub>8</sub>	G <sup>1</sup> / <sub>2</sub>	G <sup>1</sup> / <sub>2</sub>	G <sup>3</sup> / <sub>4</sub>
In main flow direction 1 → 2	650	980	1,400	2,100	2,500	7,500 (3,900) <sup>2)</sup>	8,200 (5,000) <sup>2)</sup>

1) Measured at p<sub>1</sub> = 10 bar, p<sub>2</sub> = 6 bar and Δp = 1 bar.

2) For the FRC-...D-DI.

# Service unit combinations FRC-KA, D series, metal design

Technical data combination FRC-KA

Operating and environmental conditions		
Condensate drain	Manual rotary	Fully automatic
Operating pressure [bar]	1 ... 16	2 ... 12
Operating medium	Compressed air in accordance with ISO 8573-1:2010 [-:-:-]	
	Inert gases	
Ambient temperature [°C]	-10 ... +60	
Temperature of medium [°C]	-10 ... +60	
Corrosion resistance class CRC <sup>1)</sup>	2	
Maritime classification	See certificate <sup>2)</sup>	

- 1) Corrosion resistance class CRC 2 to Festo standard FN 940070  
Moderate corrosion stress. Indoor applications in which condensation may occur. External visible parts with primarily decorative requirements for the surface and which are in direct contact with the ambient atmosphere typical for industrial applications.
- 2) Additional information [www.festo.com/sp](http://www.festo.com/sp) → Certificates.

Weight [g]			
Size	Mini	Midi	Maxi
FRC	1,000	2,400	3,500 (3,700) <sup>1)</sup>

- 1) For the FRC-...-D-DI.

-  - Note  
Materials → Technical data of the individual devices

## Standard flow rate qn as a function of the output pressure p2 FRC-1/2-D-DI-MAXI-KA(-A)

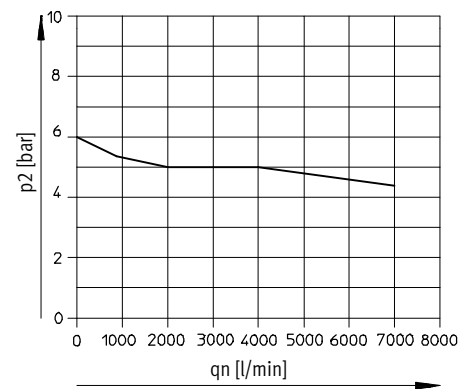

Primary pressure p1 = 10 bar

# Service unit combinations FRC-KA, D series, metal design

Technical data combination FRC-KA

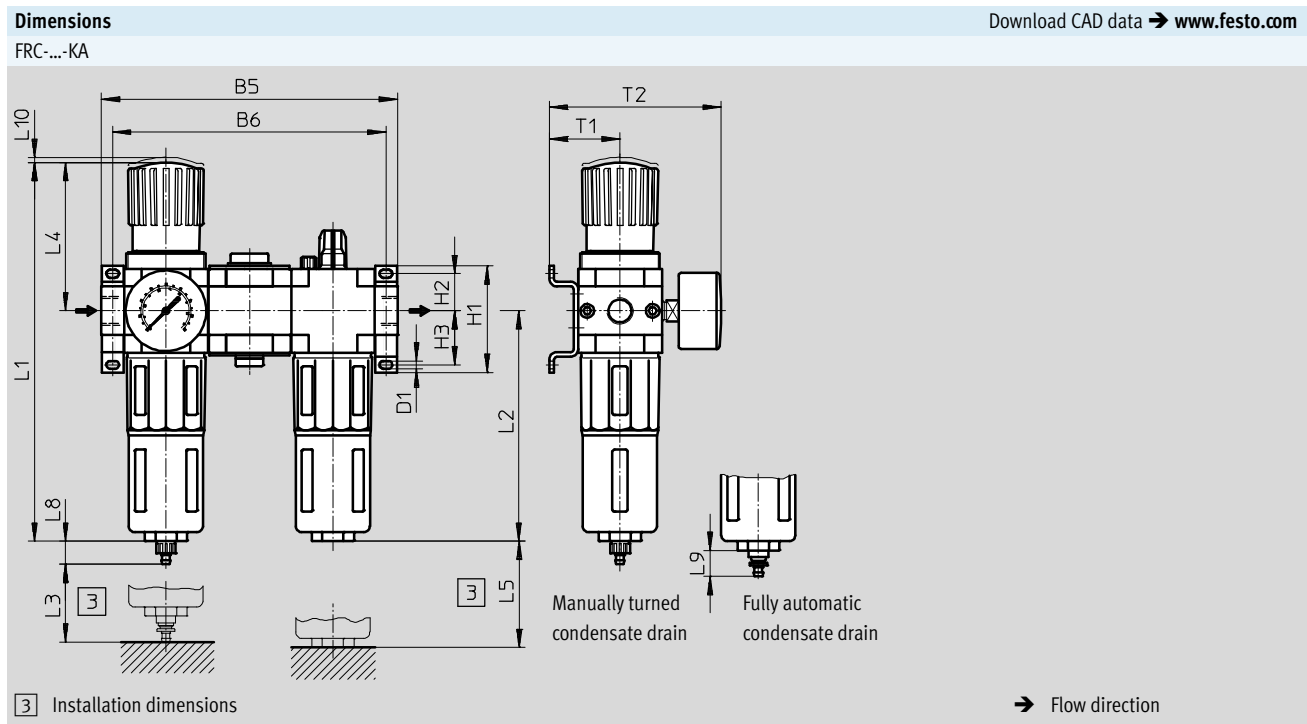

Type	B5	B6	D1	H1	H2	H3	L1	L2	L3	L4	L5	L8	L9	L10	T1	T2
<b>Mini</b>																
FRC-...-D-MINI-KA (-A)	144	132	4.3	43	17.5	17.5	193	124	60	68	100	15	19	3	39	95
<b>Midi</b>																
FRC-...-D-MIDI-KA (-A)	195	180	5.3	70	24.5	35.5	250	152	80	99	120	15	19	3	47	114
<b>Maxi</b>																
FRC-...-D-MAXI-KA (-A)	228	212	5.3	70	24.5	35.5	252	171	90	82	150	15	19	3	53	126
FRC-...-D-DI-MAXI-KA (-A)							275			105						

**Ordering data**

Pressure gauge with outer scale in bar and inner scale in psi

Size	Connection	Condensate drain turned manually		Condensate drain fully automatic	
		Part No.	Type	Part No.	Type
Mini	G1/8	185791	FRC-1/8-D-MINI-KA	185792	FRC-1/8-D-MINI-KA-A
	G1/4	185793	FRC-1/4-D-MINI-KA	185794	FRC-1/4-D-MINI-KA-A
Midi	G1/4	185795	FRC-1/4-D-MIDI-KA	185796	FRC-1/4-D-MIDI-KA-A
	G3/8	185797	FRC-3/8-D-MIDI-KA	185798	FRC-3/8-D-MIDI-KA-A
	G1/2	185799	FRC-1/2-D-MIDI-KA	185800	FRC-1/2-D-MIDI-KA-A
Maxi	G1/2	186053	FRC-1/2-D-MAXI-KA	186054	FRC-1/2-D-MAXI-KA-A
	G3/4	185801	FRC-3/4-D-MAXI-KA	185802	FRC-3/4-D-MAXI-KA-A
<b>Directly actuated pressure regulator with integrated return flow function</b>					
Maxi	G1/2	192468	FRC-1/2-D-DI-MAXI-KA	192478	FRC-1/2-D-DI-MAXI-KA-A
	G3/4	192473	FRC-3/4-D-DI-MAXI-KA	192483	FRC-3/4-D-DI-MAXI-KA-A

• Note: This product conforms to ISO 1179-1 and to ISO 228-1

# Service unit combinations FRC-KB, D series, metal design

Technical data combination FRC-KB

**Function**

With condensate drain  
manual rotary

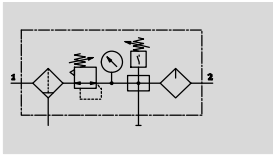

With condensate drain  
fully automatic

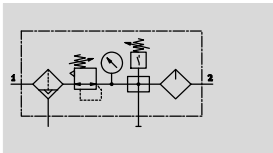

- Filter regulator LFR
- Branching module FRM with pressure switch
- Lubricator LOE
- Mounting accessories

- - Flow rate  
650 ... 8,200 l/min
- - Temperature range  
-10 ... +60 °C
- - Operating pressure  
1 ... 16 bar



- Electrical pressure monitoring with adjustable switching pressure
- For lubricated and unlubricated compressed air
- One connection for unlubricated compressed air supply
- One connection for lubricated compressed air supply
- New filter cartridges → 34

General technical data							
Size	Mini		Midi			Maxi	
Pneumatic connection 1, 2	G $\frac{1}{8}$	G $\frac{1}{4}$	G $\frac{1}{4}$	G $\frac{3}{8}$	G $\frac{1}{2}$	G $\frac{1}{2}$	G $\frac{3}{4}$
Type of mounting	Via accessories In-line installation						
Assembly position	Vertical $\pm 5^\circ$						
Grade of filtration [ $\mu\text{m}$ ]	40						
Air purity class at the output	Compressed air in accordance with ISO 8573-1:2010 [7:4:-] Inert gases						
Bowl guard	Metal bowl guard						
Condensate drain	Manual rotary Fully automatic						
Actuator lock	Rotary knob with detent						
Pressure regulation range [bar]	0.5 ... 12						
Max. hysteresis [bar]	0.25	0.2	0.25	0.35	0.35	0.1	0.2
Pressure indication	Via pressure gauge						
Max. condensate volume [ $\text{cm}^3$ ]	22		43			80 (43) <sup>1)</sup>	

1) For the FRC...-D-DI.

Note: This product conforms to ISO 1179-1 and to ISO 228-1

Standard nominal flow rate $q_{nN}^{1)}$ [l/min]							
Connection	Mini		Midi			Maxi	
	G $\frac{1}{8}$	G $\frac{1}{4}$	G $\frac{1}{4}$	G $\frac{3}{8}$	G $\frac{1}{2}$	G $\frac{1}{2}$	G $\frac{3}{4}$
In main flow direction 1 → 2	650	980	1,400	2,100	2,500	7,500 (5,400) <sup>2)</sup>	8,200 (7,000) <sup>2)</sup>

1) Measured at  $p_1 = 10 \text{ bar}$ ,  $p_2 = 6 \text{ bar}$  and  $\Delta p = 1 \text{ bar}$ .

2) For the FRC...-D-DI.

# Service unit combinations FRC-KB, D series, metal design

Technical data combination FRC-KB

Operating and environmental conditions		
Condensate drain	Manual rotary	Fully automatic
Operating pressure [bar]	1 ... 16	2 ... 12
Operating medium	Compressed air in accordance with ISO 8573-1:2010 [-:-:-]	
	Inert gases	
Ambient temperature [°C]	-10 ... +60	
Temperature of medium [°C]	-10 ... +60	
Corrosion resistance class CRC <sup>1)</sup>	2	
Maritime classification	See certificate <sup>2)</sup>	

- 1) Corrosion resistance class CRC 2 to Festo standard FN 940070  
Moderate corrosion stress. Indoor applications in which condensation may occur. External visible parts with primarily decorative requirements for the surface and which are in direct contact with the ambient atmosphere typical for industrial applications.
- 2) Additional information [www.festo.com/sp](http://www.festo.com/sp) → Certificates.

Weight [g]			
Size	Mini	Midi	Maxi
FRC	1,200	2,600	3,500 (3,700) <sup>1)</sup>

- 1) For the FRC-...-D-DI.

 Note  
Materials → Technical data of the individual devices

## Standard flow rate qn as a function of the output pressure p2 FRC-1/2-D-DI-MAXI-KB(-A)

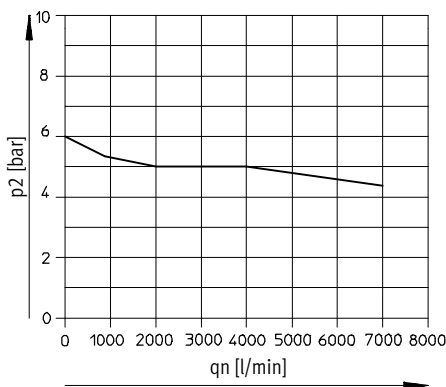

Primary pressure p1 = 10 bar

# Service unit combinations FRC-KB, D series, metal design

Technical data combination FRC-KB



## Dimensions

Download CAD data → [www.festo.com](http://www.festo.com)

FRC-...-KB

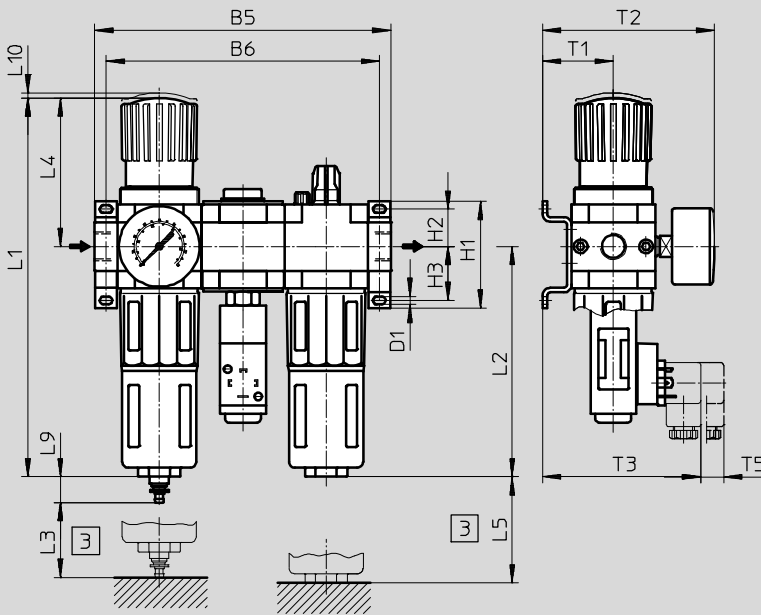

3 Installation dimensions

→ Flow direction

Type	B5	B6	D1	H1	H2	H3	L1	L2	L3	L4	L5	L9	L10	T1	T2	T3	T5
<b>Mini</b>																	
FRC-...-D-MINI-KB (-A)	144	132	4.3	43	17.5	17.5	193	124	60	68	100	19	3	39	95	97	15
<b>Midi</b>																	
FRC-...-D-MIDI-KB (-A)	195	180	5.3	70	24.5	35.5	250	152	80	99	120	19	3	47	114	105	15
<b>Maxi</b>																	
FRC-...-D-MAXI-KB (-A)	228	212	5.3	70	24.5	35.5	252	171	90	82	150	19	3	53	126	111	15
FRC-...-D-DI-MAXI-KB (-A)							275			105							

## Ordering data

Pressure gauge with outer scale in bar and inner scale in psi

Size	Connection	Condensate drain turned manually		Condensate drain fully automatic	
		Part No.	Type	Part No.	Type
Mini	G $\frac{1}{8}$	185803	FRC- $\frac{1}{8}$ -D-MINI-KB	185804	FRC- $\frac{1}{8}$ -D-MINI-KB-A
	G $\frac{1}{4}$	185805	FRC- $\frac{1}{4}$ -D-MINI-KB	185806	FRC- $\frac{1}{4}$ -D-MINI-KB-A
Midi	G $\frac{1}{4}$	185807	FRC- $\frac{1}{4}$ -D-MIDI-KB	185808	FRC- $\frac{1}{4}$ -D-MIDI-KB-A
	G $\frac{3}{8}$	185809	FRC- $\frac{3}{8}$ -D-MIDI-KB	185810	FRC- $\frac{3}{8}$ -D-MIDI-KB-A
	G $\frac{1}{2}$	185811	FRC- $\frac{1}{2}$ -D-MIDI-KB	185812	FRC- $\frac{1}{2}$ -D-MIDI-KB-A
Maxi	G $\frac{1}{2}$	186055	FRC- $\frac{1}{2}$ -D-MAXI-KB	186056	FRC- $\frac{1}{2}$ -D-MAXI-KB-A
	G $\frac{3}{4}$	185813	FRC- $\frac{3}{4}$ -D-MAXI-KB	185814	FRC- $\frac{3}{4}$ -D-MAXI-KB-A
<b>Directly actuated pressure regulator with integrated return flow function</b>					
Maxi	G $\frac{1}{2}$	192469	FRC- $\frac{1}{2}$ -D-DI-MAXI-KB	192479	FRC- $\frac{1}{2}$ -D-DI-MAXI-KB-A
	G $\frac{3}{4}$	192474	FRC- $\frac{3}{4}$ -D-DI-MAXI-KB	192484	FRC- $\frac{3}{4}$ -D-DI-MAXI-KB-A

|| Note: This product conforms to ISO 1179-1 and to ISO 228-1

# Service unit combinations FRC-KC, D series, metal design

Technical data combination FRC-KC

**Function**

With condensate drain  
manual rotary

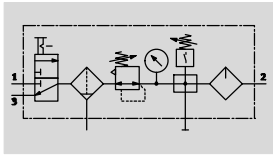

With condensate drain  
fully automatic

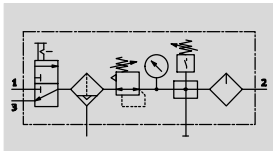

- On-off valve HE manually actuated
- Filter regulator LFR
- Branching module FRM with pressure switch
- Lubricator LOE
- Mounting accessories

- - Flow rate  
640 ... 7,800 l/min
- - Temperature range  
-10 ... +60 °C
- - Operating pressure  
1 ... 16 bar

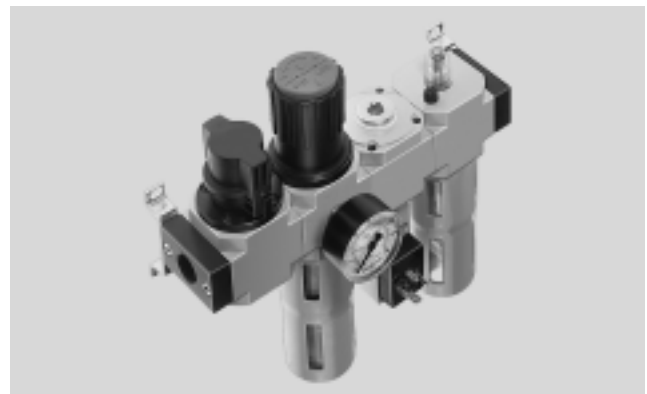

- To ensure safe venting of the system, an additional quick exhaust valve is necessary at the output of the service unit combination
- Electrical pressure monitoring with adjustable switching pressure
- The system is vented when supply air is closed
- For lubricated and unlubricated compressed air
- One connection for unlubricated compressed air supply
- One connection for lubricated compressed air supply
- New filter cartridges → 34

General technical data							
Size	Mini		Midi			Maxi	
Pneumatic connection 1, 2	G1/8	G1/4	G1/4	G3/8	G1/2	G1/2	G3/4
Type of mounting	Via accessories In-line installation						
Assembly position	Vertical ±5°						
Grade of filtration [µm]	40						
Air purity class at the output	Compressed air in accordance with ISO 8573-1:2010 [7:4:-] Inert gases						
Bowl guard	Metal bowl guard						
Condensate drain	Manual rotary Fully automatic						
Actuator lock	Rotary knob with detent						
Pressure regulation range [bar]	0.5 ... 12						
Max. hysteresis [bar]	0.2	0.2	0.4	0.3	0.3	0.15	0.15
Pressure indication	Via pressure gauge						
Max. condensate volume [cm <sup>3</sup> ]	22		43			80 (43) <sup>1)</sup>	

1) For the FRC-...-D-DI.

- ¶ - Note: This product conforms to ISO 1179-1 and to ISO 228-1

Standard nominal flow rate $q_{nN}^{1)}$ [l/min]							
Connection	Mini		Midi			Maxi	
	G1/8	G1/4	G1/4	G3/8	G1/2	G1/2	G3/4
In main flow direction 1 → 2	640	870	1,320	1,870	2,400	6,600 (4,800) <sup>2)</sup>	7,800 (5,400) <sup>2)</sup>

1) Measured at p<sub>1</sub> = 10 bar, p<sub>2</sub> = 6 bar and Δp = 1 bar.

2) For the FRC-...-D-DI.

# Service unit combinations FRC-KC, D series, metal design

Technical data combination FRC-KC

Operating and environmental conditions		
Condensate drain	Manual rotary	Fully automatic
Operating pressure [bar]	1 ... 16	1.5 ... 12
Operating medium	Compressed air in accordance with ISO 8573-1:2010 [-:-:-]	
	Inert gases	
Ambient temperature [°C]	-10 ... +60	
Temperature of medium [°C]	-10 ... +60	
Corrosion resistance class CRC <sup>1)</sup>	2	
Maritime classification	See certificate <sup>2)</sup>	

- 1) Corrosion resistance class CRC 2 to Festo standard FN 940070  
Moderate corrosion stress. Indoor applications in which condensation may occur. External visible parts with primarily decorative requirements for the surface and which are in direct contact with the ambient atmosphere typical for industrial applications.
- 2) Additional information [www.festo.com/sp](http://www.festo.com/sp) → Certificates.

Weight [g]			
Size	Mini	Midi	Maxi
FRC	1,400	3,000	4,600 (4,800) <sup>1)</sup>

- 1) For the FRC-...-D-DI.

 Note  
Materials → Technical data of the individual devices

## Standard flow rate qn as a function of the output pressure p2

FRC-1/2-D-DI-MAXI-KC(-A)

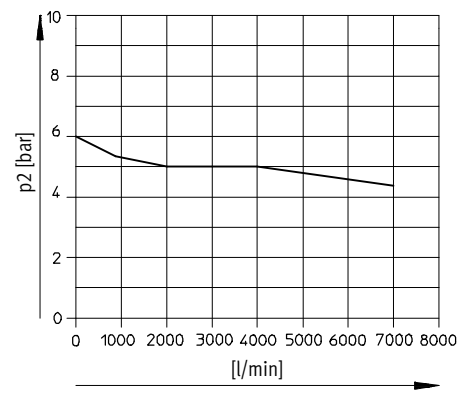

Primary pressure p1 = 10 bar



# Service unit combinations FRC-KC, D series, metal design

Technical data combination FRC-KC

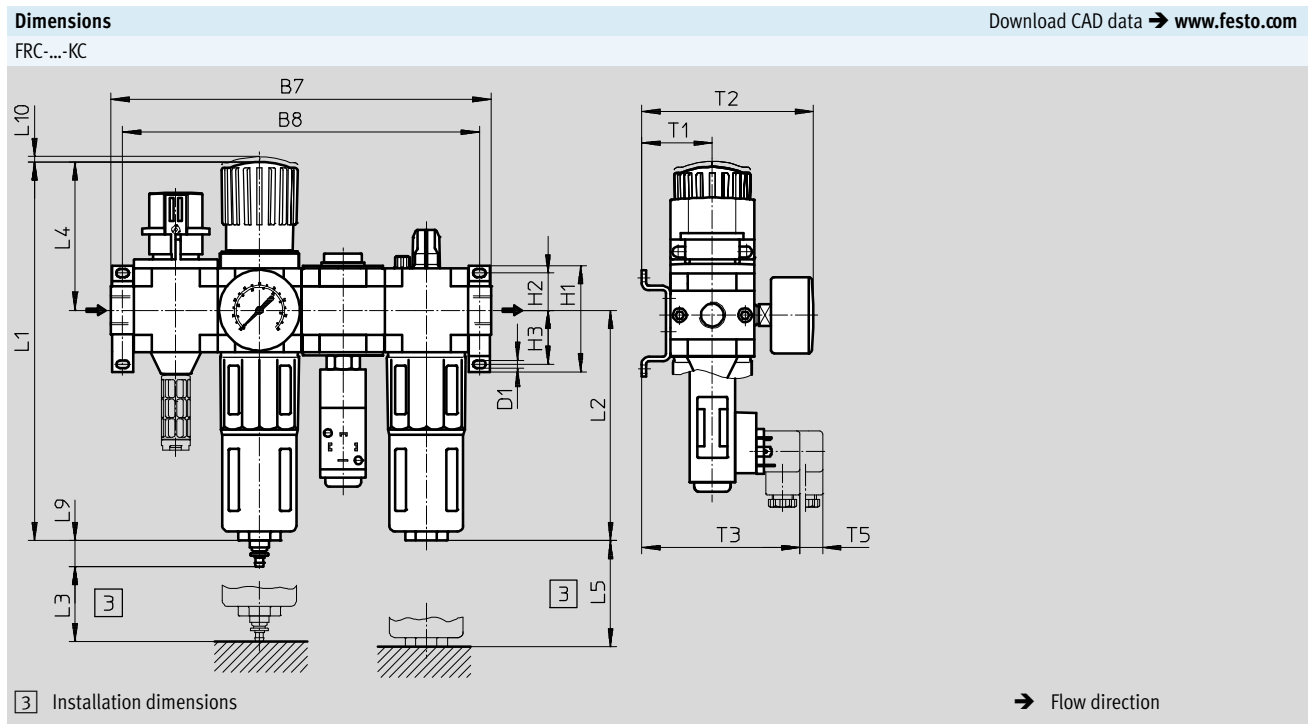

Type	B7	B8	D1	H1	H2	H3	L1	L2	L3	L4	L5	L9	L10	T1	T2	T3	T5
<b>Mini</b>																	
FRC-...-D-MINI-KC (-A)	184	172	4.3	43	17.5	17.5	193	124	60	68	100	19	3	39	95	97	15
<b>Midi</b>																	
FRC-...-D-MIDI-KC (-A)	250	235	5.3	70	24.5	35.5	250	152	80	99	120	19	3	47	114	105	15
<b>Maxi</b>																	
FRC-...-D-MAXI-KC (-A)	294	278	5.3	70	24.5	35.5	252	171	90	82	150	19	3	53	126	111	15
FRC-...-D-DI-MAXI-KC (-A)							275			105							

**Ordering data**

Pressure gauge with outer scale in bar and inner scale in psi

Size	Connection	Condensate drain turned manually		Condensate drain fully automatic	
		Part No.	Type	Part No.	Type
Mini	G1/8	185815	FRC-1/8-D-MINI-KC	185816	FRC-1/8-D-MINI-KC-A
	G1/4	185817	FRC-1/4-D-MINI-KC	185818	FRC-1/4-D-MINI-KC-A
Midi	G1/4	185819	FRC-1/4-D-MIDI-KC	185820	FRC-1/4-D-MIDI-KC-A
	G3/8	185821	FRC-3/8-D-MIDI-KC	185822	FRC-3/8-D-MIDI-KC-A
	G1/2	185823	FRC-1/2-D-MIDI-KC	185824	FRC-1/2-D-MIDI-KC-A
Maxi	G1/2	186057	FRC-1/2-D-MAXI-KC	186058	FRC-1/2-D-MAXI-KC-A
	G3/4	185825	FRC-3/4-D-MAXI-KC	185826	FRC-3/4-D-MAXI-KC-A
<b>Directly actuated pressure regulator with integrated return flow function</b>					
Maxi	G1/2	192470	FRC-1/2-D-DI-MAXI-KC	192480	FRC-1/2-D-DI-MAXI-KC-A
	G3/4	192475	FRC-3/4-D-DI-MAXI-KC	192485	FRC-3/4-D-DI-MAXI-KC-A

• Note: This product conforms to ISO 1179-1 and to ISO 228-1

# Service unit combinations FRC-KE, D series, metal design

Technical data combination FRC-KE

Function

With condensate drain  
manual rotary

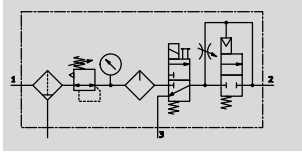

With condensate drain  
fully automatic

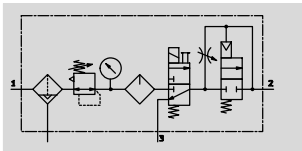

- Flow rate  
550 ... 3,800 l/min
- Temperature range  
-10 ... +60 °C
- Operating pressure  
3 ... 16 bar



- Filter regulator LFR
- Lubricator LOE
- On-off valve HEE solenoid actuated, 24 V DC
- Soft-start valve HEL pneumatically actuated
- Mounting accessories

- Gradual pressure build-up prevents sudden, unpredictable movements
- For lubricated compressed air
- New filter cartridges → 34
- When supply pressure is closed, quick venting ensures rapid pressure reduction

General technical data							
Size	Mini		Midi			Maxi	
Pneumatic connection 1, 2	G <sup>1</sup> / <sub>8</sub>	G <sup>1</sup> / <sub>4</sub>	G <sup>1</sup> / <sub>4</sub>	G <sup>3</sup> / <sub>8</sub>	G <sup>1</sup> / <sub>2</sub>	G <sup>1</sup> / <sub>2</sub>	G <sup>3</sup> / <sub>4</sub>
Type of mounting	Via accessories In-line installation						
Assembly position	Vertical ±5°						
Grade of filtration [µm]	40						
Air purity class at the output	Compressed air in accordance with ISO 8573-1:2010 [7:4:-] Inert gases						
Bowl guard	Metal bowl guard						
Condensate drain	Manual rotary Fully automatic						
Actuator lock	Rotary knob with detent						
Pressure regulation range [bar]	2.5 ... 12						
Max. hysteresis [bar]	0.15	0.15	0.25	0.2	0.4	0.3	0.3
Pressure indication	Via pressure gauge						
Max. condensate volume [cm <sup>3</sup> ]	22		43			80 (43) <sup>1)</sup>	

1) For the FRC...-D-DI.

- | - Note: This product conforms to ISO 1179-1 and to ISO 228-1

Standard nominal flow rate $q_{nN}^{1)}$ [l/min]							
Connection	Mini		Midi			Maxi	
	G <sup>1</sup> / <sub>8</sub>	G <sup>1</sup> / <sub>4</sub>	G <sup>1</sup> / <sub>4</sub>	G <sup>3</sup> / <sub>8</sub>	G <sup>1</sup> / <sub>2</sub>	G <sup>1</sup> / <sub>2</sub>	G <sup>3</sup> / <sub>4</sub>
In main flow direction 1 → 2	550	650	1,100	1,420	1,590	3,500 (2,900) <sup>2)</sup>	3,800 (3,300) <sup>2)</sup>

1) Measured at p<sub>1</sub> = 10 bar, p<sub>2</sub> = 6 bar and Δp = 1 bar.

2) For the FRC...-D-DI.

# Service unit combinations FRC-KE, D series, metal design

Technical data combination FRC-KE

Operating and environmental conditions		
Condensate drain	Manual rotary	Fully automatic
Operating pressure [bar]	3 ... 16	3 ... 12
Operating medium	Compressed air in accordance with ISO 8573-1:2010 [-:-:-]	
	Inert gases	
Ambient temperature [°C]	-10 ... +60	
Temperature of medium [°C]	-10 ... +60	
Corrosion resistance class CRC <sup>1)</sup>	2	
Maritime classification	See certificate <sup>2)</sup>	

- 1) Corrosion resistance class CRC 2 to Festo standard FN 940070  
Moderate corrosion stress. Indoor applications in which condensation may occur. External visible parts with primarily decorative requirements for the surface and which are in direct contact with the ambient atmosphere typical for industrial applications.
- 2) Additional information [www.festo.com/sp](http://www.festo.com/sp) → Certificates.

Weight [g]			
Size	Mini	Midi	Maxi
FRC	1,200	2,800	4,200 (4,400) <sup>1)</sup>

1) For the FRC-...-D-DI.

 Note  
Materials → Technical data of the individual devices

## Standard flow rate qn as a function of the output pressure p2 FRC-1/2-D-DI-MAXI-KE(-A)

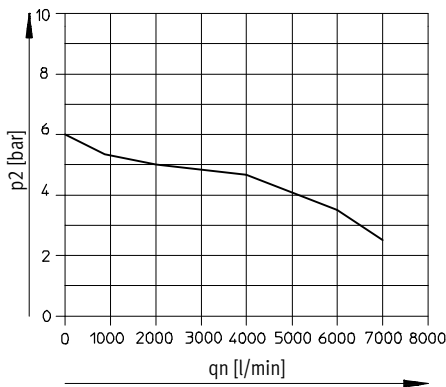

Primary pressure p1 = 10 bar

# Service unit combinations FRC-KE, D series, metal design

Technical data combination FRC-KE

FESTO

## Dimensions

Download CAD data → [www.festo.com](http://www.festo.com)

FRC-...-KE

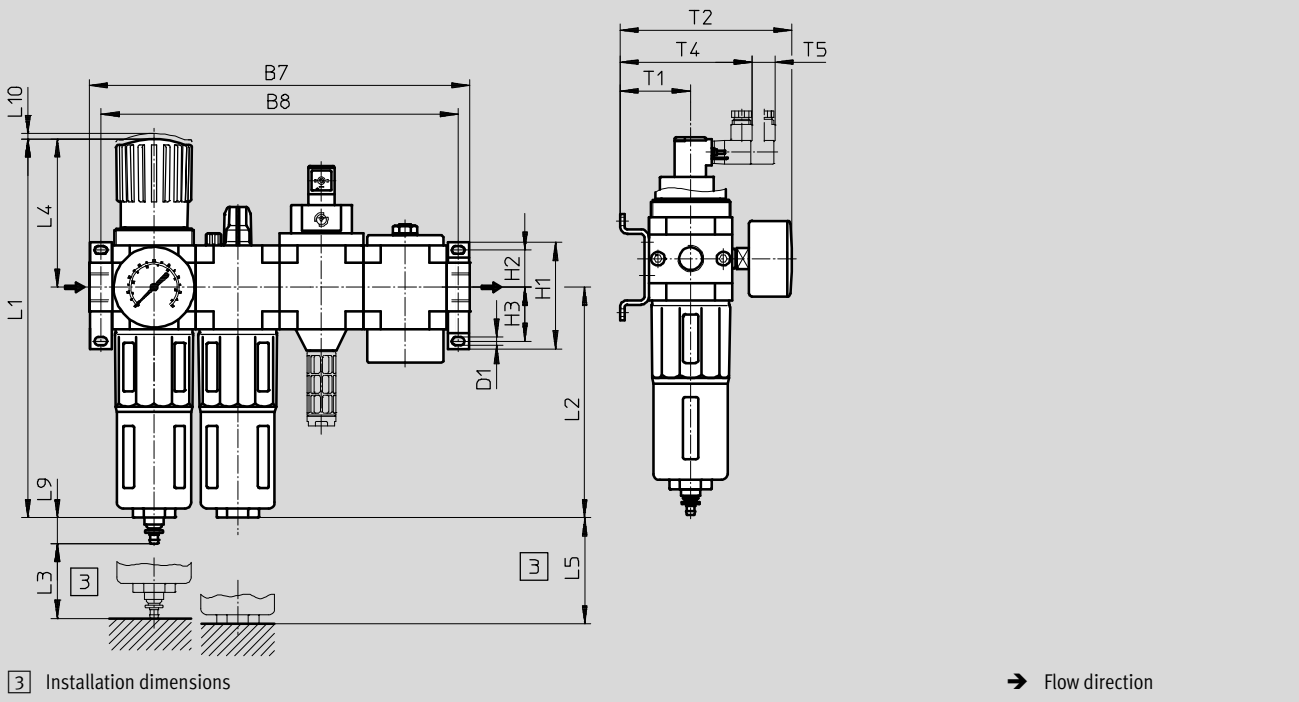

Type	B7	B8	D1	H1	H2	H3	L1	L2	L3	L4	L5	L9	L10	T1	T2	T4	T5
<b>Mini</b>																	
FRC-...-D-MINI-KE (-A)	184	172	4.3	43	17.5	17.5	193	124	60	68	100	19	3	39	95	78	15
<b>Midi</b>																	
FRC-...-D-MIDI-KE (-A)	250	235	5.3	70	24.5	35.5	250	152	80	99	120	19	3	47	114	86	15
<b>Maxi</b>																	
FRC-...-D-MAXI-KE (-A)	294	278	5.3	70	24.5	35.5	252	171	90	82	150	19	3	53	126	92	15
FRC-...-D-DI-MAXI-KE (-A)							275			105							

## Ordering data

Pressure gauge with outer scale in bar and inner scale in psi

Size	Connection	Condensate drain turned manually		Condensate drain fully automatic	
		Part No.	Type	Part No.	Type
Mini	G1/8	185827	FRC-1/8-D-MINI-KE	185828	FRC-1/8-D-MINI-KE-A
	G1/4	185829	FRC-1/4-D-MINI-KE	185830	FRC-1/4-D-MINI-KE-A
Midi	G1/4	185831	FRC-1/4-D-MIDI-KE	185832	FRC-1/4-D-MIDI-KE-A
	G3/8	185833	FRC-3/8-D-MIDI-KE	185834	FRC-3/8-D-MIDI-KE-A
	G1/2	185835	FRC-1/2-D-MIDI-KE	185836	FRC-1/2-D-MIDI-KE-A
Maxi	G1/2	186059	FRC-1/2-D-MAXI-KE	186060	FRC-1/2-D-MAXI-KE-A
	G3/4	185837	FRC-3/4-D-MAXI-KE	185838	FRC-3/4-D-MAXI-KE-A
<b>Directly actuated pressure regulator with integrated return flow function</b>					
Maxi	G1/2	192471	FRC-1/2-D-DI-MAXI-KE	192481	FRC-1/2-D-DI-MAXI-KE-A
	G3/4	192476	FRC-3/4-D-DI-MAXI-KE	192486	FRC-3/4-D-DI-MAXI-KE-A

◆ Note: This product conforms to ISO 1179-1 and to ISO 228-1

# Service unit combinations FRC-KF, D series, metal design

Technical data combination FRC-KF

Function  
With condensate drain  
manual rotary

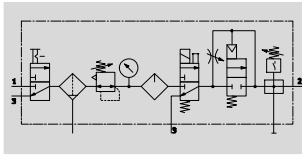

With condensate drain  
fully automatic

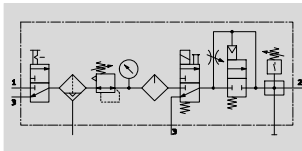

- On-off valve HE manually actuated
- Filter regulator LFR
- Lubricator LOE
- On-off valve HEE solenoid actuated, 24 V DC
- Soft-start valve HEL pneumatically actuated
- Branching module FRM with pressure switch
- Mounting accessories

- - Flow rate  
530 ... 6,000 l/min
- - Temperature range  
-10 ... +60 °C
- - Operating pressure  
3 ... 16 bar

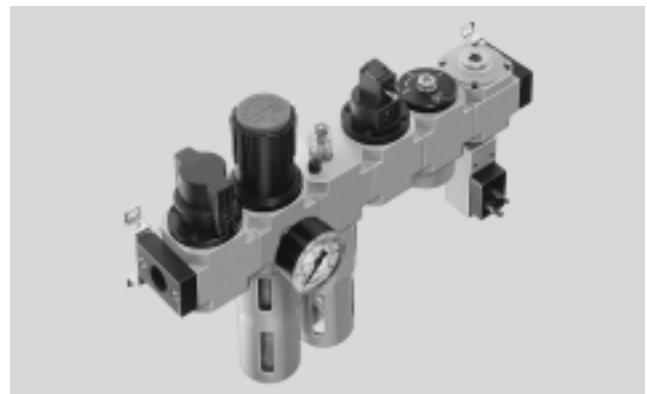

- Gradual pressure build-up prevents sudden, unpredictable movements
- To ensure safe venting of the system, an additional quick exhaust valve is necessary at the output of the service unit combination
- For lubricated compressed air
- Two branch connections are available
- Supply pressure can be opened and closed
- New filter cartridges → 34 combination

General technical data							
Size	Mini			Midi		Maxi	
Pneumatic connection 1, 2	G1/8	G1/4	G1/4	G3/8	G1/2	G1/2	G3/4
Type of mounting	Via accessories						
	In-line installation						
Assembly position	Vertical ±5°						
Grade of filtration [µm]	40						
Air purity class at the output	Compressed air in accordance with ISO 8573-1:2010 [7:4:-]						
	Inert gases						
Bowl guard	Metal bowl guard						
Condensate drain	Manual rotary						
	Fully automatic						
Actuator lock	Rotary knob with detent						
Pressure regulation range [bar]	2.5 ... 12						
Max. hysteresis [bar]	0.2	0.3	0.25	0.3	0.25	0.3	0.25
Pressure indication	Via pressure gauge						
Max. condensate volume [cm <sup>3</sup> ]	22		43			80 (43) <sup>1)</sup>	

1) For the FRC-...-D-DI.

- - Note: This product conforms to ISO 1179-1 and to ISO 228-1

Standard nominal flow rate $q_{nN}^{1)}$ [l/min]							
Connection	Mini		Midi			Maxi	
	G1/8	G1/4	G1/4	G3/8	G1/2	G1/2	G3/4
In main flow direction 1 → 2	530	620	1,060	1,150	1,220	3,400 (5,000) <sup>2)</sup>	3,700 (6,000) <sup>2)</sup>

1) Measured at p<sub>1</sub> = 10 bar, p<sub>2</sub> = 6 bar and Δp = 1 bar.

2) For the FRC-...-D-DI.

# Service unit combinations FRC-KF, D series, metal design

Technical data combination FRC-KF

Operating and environmental conditions		
Condensate drain	Manual rotary	Fully automatic
Operating pressure [bar]	3 ... 16	
Operating medium	Compressed air in accordance with ISO 8573-1:2010 [-:-:-]	
	Inert gases	
Ambient temperature [°C]	-10 ... +60	
Temperature of medium [°C]	-10 ... +60	
Corrosion resistance class CRC <sup>1)</sup>	2	
Maritime classification	See certificate <sup>2)</sup>	

- 1) Corrosion resistance class CRC 2 to Festo standard FN 940070  
Moderate corrosion stress. Indoor applications in which condensation may occur. External visible parts with primarily decorative requirements for the surface and which are in direct contact with the ambient atmosphere typical for industrial applications.
- 2) Additional information [www.festo.com/sp](http://www.festo.com/sp) → Certificates.

Weight [g]			
Size	Mini	Midi	Maxi
FRC	1,800	4,000	6,300 (6,500) <sup>1)</sup>

- 1) For the FRC-...-D-DI.

-  - Note  
Materials → Technical data of the individual devices

## Standard flow rate qn as a function of the output pressure p2

FRC-1/2-D-DI-MAXI-KF(-A)

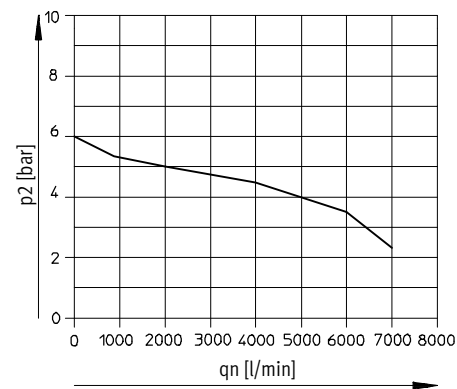

Primary pressure p1 = 10 bar

# Service unit combinations FRC-KF, D series, metal design

Technical data combination FRC-KF

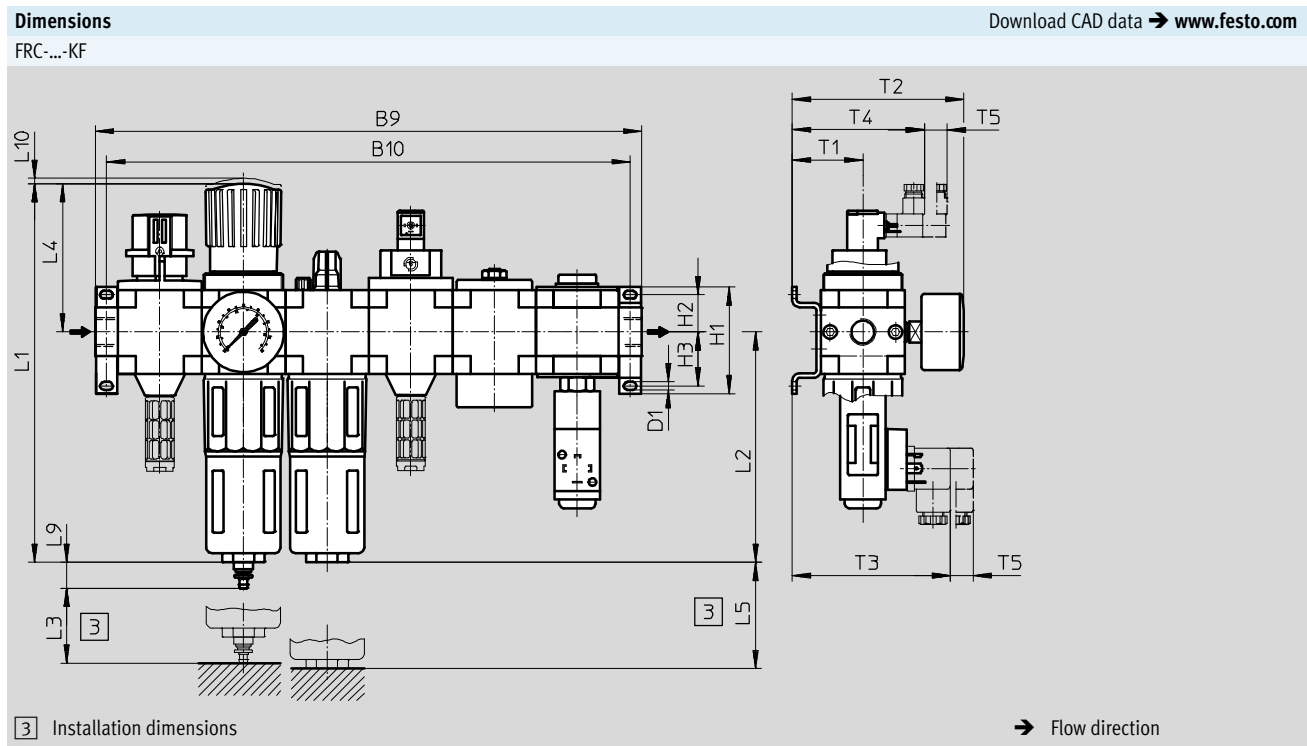

Type	B9	B10	D1	H1	H2	H3	L1	L2	L3	L4	L5	L9	L10	T1	T2	T3	T4	T5
<b>Mini</b>																		
FRC-...-D-MINI-KF (-A)	264	252	4.3	43	17.5	17.5	193	124	60	68	100	19	3	39	95	97	78	15
<b>Midi</b>																		
FRC-...-D-MIDI-KF (-A)	360	344	5.3	70	24.5	35.5	250	152	80	99	120	19	3	47	114	105	86	15
<b>Maxi</b>																		
FRC-...-D-MAXI-KF (-A)	426	410	5.3	70	24.5	35.5	252	171	90	82	150	19	3	53	126	111	92	15
FRC-...-D-DI-MAXI-KF (-A)							275			105								

**Ordering data**



Pressure gauge with outer scale in bar and inner scale in psi

Size	Connection	Condensate drain turned manually		Condensate drain fully automatic	
		Part No.	Type	Part No.	Type
Mini	G1/8	185839	FRC-1/8-D-MINI-KF	185840	FRC-1/8-D-MINI-KF-A
	G1/4	185841	FRC-1/4-D-MINI-KF	185842	FRC-1/4-D-MINI-KF-A
Midi	G1/4	185843	FRC-1/4-D-MIDI-KF	185844	FRC-1/4-D-MIDI-KF-A
	G3/8	185845	FRC-3/8-D-MIDI-KF	185846	FRC-3/8-D-MIDI-KF-A
	G1/2	185847	FRC-1/2-D-MIDI-KF	185848	FRC-1/2-D-MIDI-KF-A
Maxi	G1/2	186061	FRC-1/2-D-MAXI-KF	186062	FRC-1/2-D-MAXI-KF-A
	G3/4	185849	FRC-3/4-D-MAXI-KF	185850	FRC-3/4-D-MAXI-KF-A
<b>Directly actuated pressure regulator with integrated return flow function</b>					
Maxi	G1/2	192472	FRC-1/2-D-DI-MAXI-KF	192482	FRC-1/2-D-DI-MAXI-KF-A
	G3/4	192477	FRC-3/4-D-DI-MAXI-KF	192487	FRC-3/4-D-DI-MAXI-KF-A

Note: This product conforms to ISO 1179-1 and to ISO 228-1

# Service unit combinations FRC-K, D series, polymer

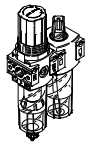
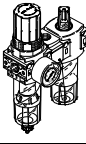
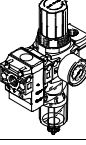
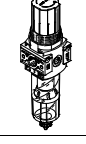
Product range overview D series service units, polymer

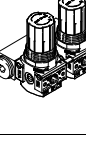
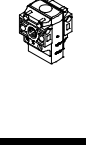
Type	Size	Pneumatic connection		Pressure regulation range [bar]	Grade of filtration [µm]		
		G¼	G½		5	40	
<b>Service units</b>							
FRC		Mini	■	-	■	■	■
<b>Service unit combinations</b>							
FRC-K		Mini	■	-	■	-	■
LFR-K		Mini	■	-	■	-	■
<b>Individual devices</b>							
Filter regulators LFR		Mini	■	-	■	■	■
Pressure regulators LR		Mini	■	-	■	-	-
Pressure regulator combinations LRB-K		Mini	-	■	■	-	-
On-off valves HE		Mini	■	-	-	-	-



# Service unit combinations FRC-K, D series, polymer

Product range overview D series service units, polymer

Type	Size	Condensate drain		Pressure display		Actuator lock	Regulating functions		→ Page/ Internet
		Manual rotary	Semi-automatic	With pressure gauge	Without pressure gauge		With secondary venting	With return flow function	
<b>Service units</b>									
FRC	Mini	■	■	■	-	■	■	■	frc
<b>Service unit combinations</b>									
FRC-K	Mini	■	-	■	-	■	■	■	26
LFR-K	Mini	■	-	■	-	■	■	■	lfr
<b>Individual devices</b>									
Filter regulators LFR	Mini	■	■	■	■	■	■	■	lfr
Pressure regulators LR	Mini	-	-	■	■	■	■	■	lr
Pressure regulator combinations LRB-K	Mini	-	-	-	■	■	■	■	lrb
On-off valves HE	Mini	-	-	-	■	-	-	-	he

# Service unit combinations FRC-K, D series, polymer

Peripherals overview

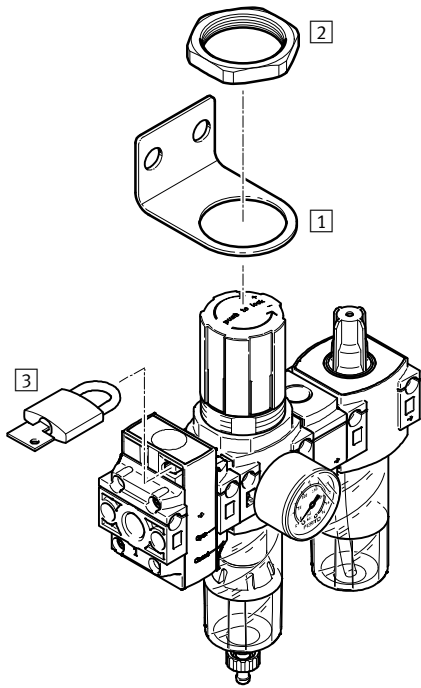

**Note**  
 The range of accessories depends on the selected service unit combination. The example shows the service unit combination FRC-KC.

Mounting components and accessories		→ Page/Internet
1	Mounting bracket HR-D	hr-d
2	Hex nut HMR	hmr-d
3	Padlock LRVS	lrvs-d
-	Filter cartridge MS4-LFP-E	34
-	Special oil OFSW	34

# Service unit combinations FRC-K, D series, polymer

Type codes

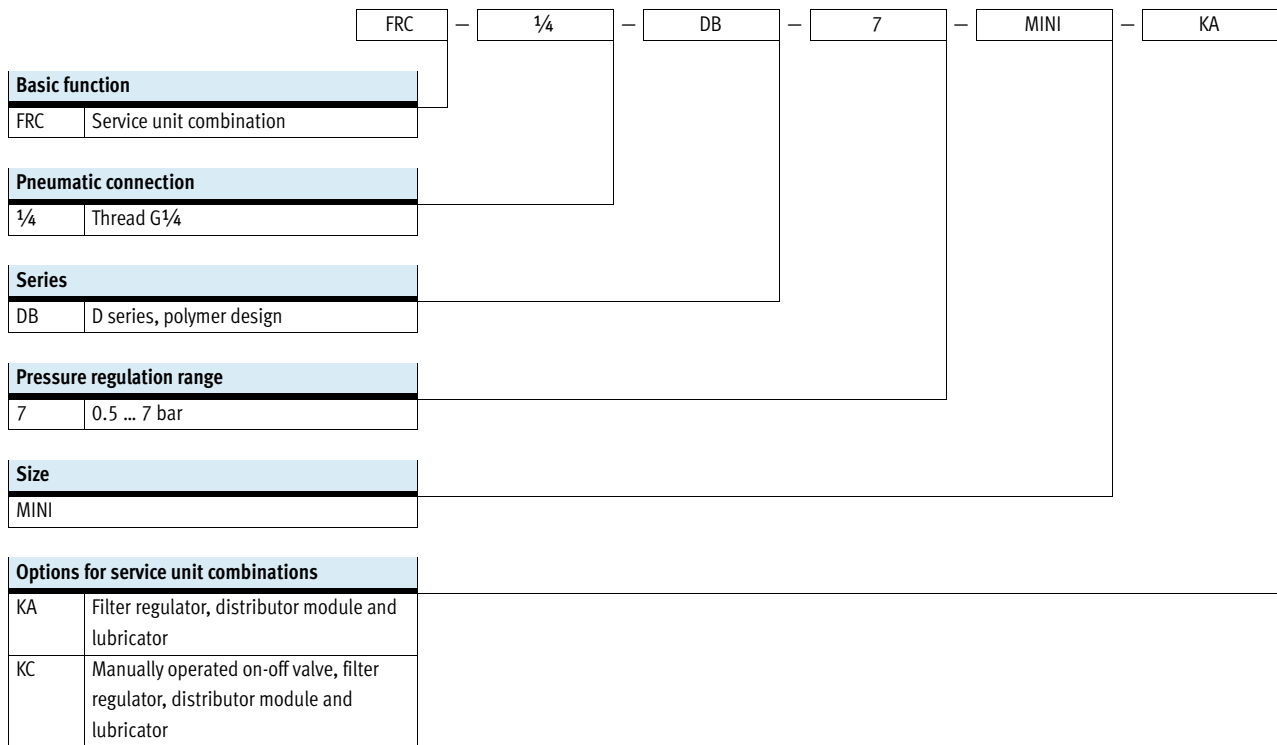

# Service unit combinations FRC-KA, D series, polymer

Technical data – FRC-KA combination

Function

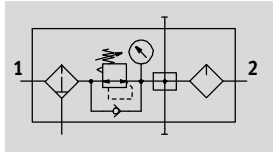

- Filter regulator
- Distributor module
- Lubricator

- - Standard nominal flow rate  
700 l/min
- - Temperature range  
-5 ... +50 °C
- - Operating pressure  
1.5 ... 10 bar



- For filtered and lubricated compressed air
- Output pressure is infinitely adjustable within the pressure regulation range

- Removal of filtered and unlubricated compressed air at the distributor module ports
- New filter cartridges → 34

The following oils are recommended for Festo components:  
Viscosity range to  
ISO 3448 class VG 32  
32 mm<sup>2</sup>/s (cSt) at 40 °C

- Approved oils:
- Festo special oil → 34
  - ARAL Vitam GF 32
  - BP Energol HLP 32
  - Esso Nuto H 32
  - Mobil DTE 24
  - Shell Tellus Oil DO 32

General technical data	
Size	Mini
Pneumatic connection 1, 2, 3	G <sup>1</sup> / <sub>4</sub>
Design	Filter regulator/distributor module/lubricator
Regulator type	Output pressure constant, without primary pressure compensation, with return flow action, with secondary venting
Type of mounting	In-line installation Via through-hole Via mounting bracket
Mounting position	Vertical ±5°
Grade of filtration [µm]	40
Condensate drain	Manual rotary
Actuation security	Rotary knob with detent
Pressure regulation range [bar]	0.5 ... 7
Max. pressure hysteresis [bar]	0.5
Pressure indication	Via pressure gauge
Pressure gauge connection	G <sup>1</sup> / <sub>8</sub>
Max. condensate volume [ml]	13

Flow rates [l/min]	
Standard nominal flow rate $q_{nN}^{1)}$	700
Max. standard flow rate	2,500

1) Measured at p<sub>1</sub> = 10 bar, p<sub>2</sub> = 6 bar and Δp = 1 bar.

- - Note  
The design allows for slight leakage at the outlet. It improves the control response of the controller without input pressure compensation. In rare cases, however, the leakage can sporadically be up to 500 l/h.

# Service unit combinations FRC-KA, D series, polymer

Technical data – FRC-KA combination

Operating and environmental conditions	
Operating pressure [bar]	1.5 ... 10
Operating medium	Compressed air according to ISO 8573-1:2010 [7:9:4]
Note on operating/pilot medium	Lubricated operation not possible
Ambient temperature [°C]	-5 ... +50
Temperature of medium [°C]	-5 ... +50
Storage temperature [°C]	-5 ... +50
Corrosion resistance class CRC <sup>1)</sup>	1

- 1) Corrosion resistance class CRC 1 to Festo standard FN 940070  
 Low corrosion stress. For dry indoor applications or transport and storage protection. Also applies to parts behind covers, in the non-visible interior area, and parts which are covered in the application (e.g. drive trunnions).

Weight [g]	
Service unit	285

Materials	
Housing	PA reinforced
Bowl	PC
Rotary knob	POM
Filter	PE
Seals	NBR
Note on materials	RoHS-compliant

## Standard flow rate $q_n$ as a function of the output pressure $p_2$

FRC-1/4-DB-7-MINI-KA

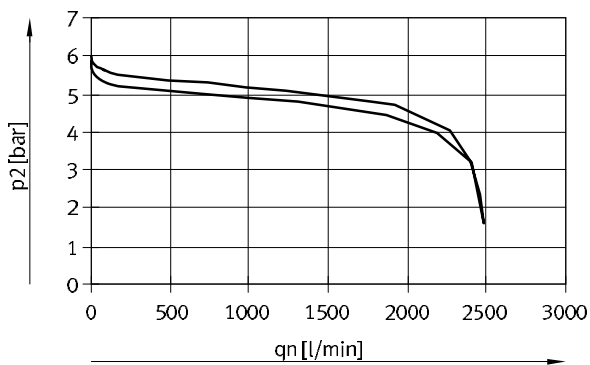

Input pressure  $p_1 = 10$  bar

# Service unit combinations FRC-KA, D series, polymer

Technical data – FRC-KA combination



## Dimensions

Download CAD data → [www.festo.com](http://www.festo.com)

Mini

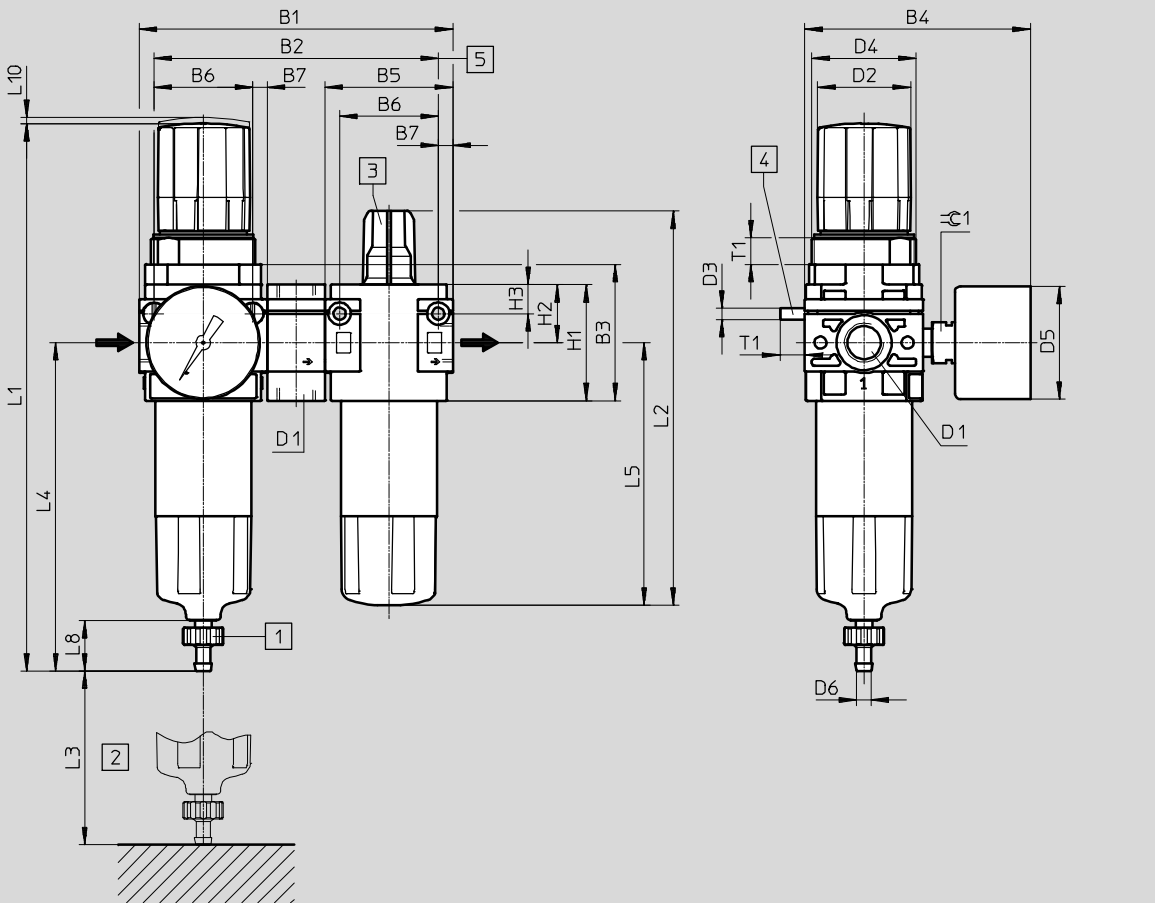

- 1 Barbed connector for plastic tubing PUN(-H)-8x1,25
- 2 Installation dimensions
- 3 Oil adjusting screw
- 4 M4 socket head screw for wall mounting (2 included in the scope of delivery)
- 5 Recommended through-holes for wall mounting via socket head screws
- Flow direction

Type	D1	B1	B2	B3	B4	B5	B6	B7	D2	D3	D4	D5	D6
FRC-1/4-DB	G1/4	108	98	47	78	44	34	5	∅ 32	M4	M36x1.5	∅ 39	∅ 5.6

Type	H1	H2	H3	L1	L2	L3 min.	L4	L5	L8	L10	T1	≈C 1
FRC-1/4-DB	40	20	10	189	136	60	113	91	17	2	9	14

## Ordering data

Condensate drain	Size	Connection	Grade of filtration 40 µm	
			Part No.	Type
Pressure gauge with outer scale in bar and inner scale in psi				
Manual rotary	Mini	G1/4	<b>8002800</b>	<b>FRC-1/4-DB-7-MINI-KA</b>

# Service unit combinations FRC-KC, D series, polymer

Technical data – FRC-KC combination

Function

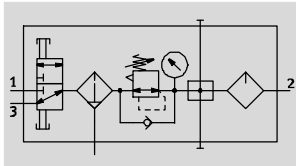

- - Standard nominal flow rate 400 l/min
- - Temperature range -5 ... +50 °C
- - Operating pressure 1.5 ... 10 bar



- Manually operated on-off valve
- Filter regulator
- Distributor module
- Lubricator

- For filtered and lubricated compressed air
- The operating pressure can be switched on or off
- Output pressure is infinitely adjustable within the pressure regulation range

- The unit is vented when switched off
- Removal of filtered and unlubricated compressed air at the distributor module ports
- New filter cartridges → 34

The following oils are recommended for Festo components:  
Viscosity range to ISO 3448 class VG 32  
32 mm<sup>2</sup>/s (cSt) at 40 °C

- Approved oils:
- Festo special oil → 34
  - ARAL Vitam GF 32
  - BP Energol HLP 32
  - Esso Nuto H 32
  - Mobil DTE 24
  - Shell Tellus Oil DO 32

General technical data	
Size	Mini
Pneumatic connection 1, 2, 3	G1/4
Design	On-off valve/filter regulator/distributor module/lubricator
Regulator type	Output pressure constant, without primary pressure compensation, with return flow action, with secondary venting
Type of mounting	In-line installation Via through-hole Via mounting bracket
Mounting position	Vertical ±5°
Actuation type	Manual
Grade of filtration [µm]	40
Condensate drain	Manual rotary
Actuation security	Rotary knob with detent Padlock (optional)
Exhaust function	No flow control
Pressure regulation range [bar]	0.5 ... 7
Max. pressure hysteresis [bar]	0.5
Pressure indication	Via pressure gauge
Pressure gauge connection	G1/8
Max. condensate volume [ml]	13

Flow rates [l/min]	
Standard nominal flow rate $q_{nN}^{1)}$	400
Max. standard flow rate	2,400

1) Measured at p1 = 10 bar, p2 = 6 bar and Δp = 1 bar.

- - Note  
The design allows for slight leakage at the outlet. It improves the control response of the controller without input pressure compensation. In rare cases, however, the leakage can sporadically be up to 500 l/h.

# Service unit combinations FRC-KC, D series, polymer

Technical data – FRC-KC combination

Operating and environmental conditions	
Operating pressure [bar]	1.5 ... 10
Operating medium	Compressed air according to ISO 8573-1:2010 [7:9:4]
Note on operating/pilot medium	Lubricated operation not possible
Ambient temperature [°C]	-5 ... +50
Temperature of medium [°C]	-5 ... +50
Storage temperature [°C]	-5 ... +50
Corrosion resistance class CRC <sup>1)</sup>	1

1) Corrosion resistance class CRC 1 to Festo standard FN 940070  
 Low corrosion stress. For dry indoor applications or transport and storage protection. Also applies to parts behind covers, in the non-visible interior area, and parts which are covered in the application (e.g. drive trunnions).

Weight [g]	
Service unit	360

Materials	
Housing	PA reinforced
Piston spool	POM
Bowl	PC
Rotary knob	POM
Filter	PE
Seals	NBR
On-off valve seals	FPM
Note on materials	RoHS-compliant

## Standard flow rate qn as a function of the output pressure p2 FRC-1/4-DB-7-MINI-KC

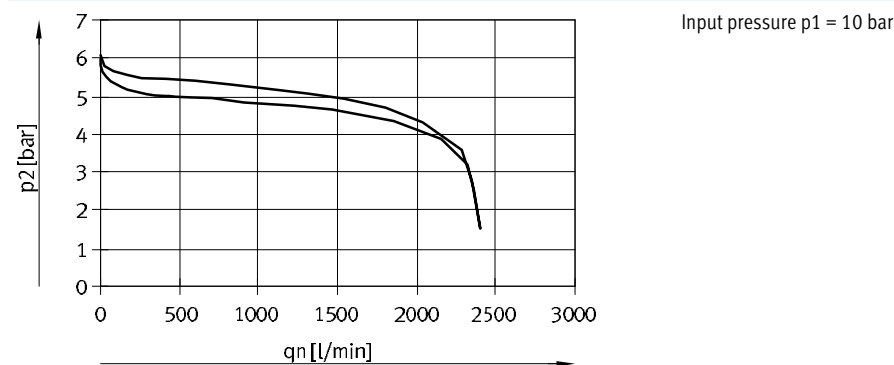



# Service unit combinations FRC-KC, D series, polymer

Technical data – FRC-KC combination

Dimensions Download CAD data → [www.festo.com](http://www.festo.com)

Mini

1 Barbed connector for plastic tubing PUN(-H)-8x1,25  
 2 Installation dimensions  
 3 Oil adjusting screw  
 4 M4 socket head screw for wall mounting (2 included in the scope of delivery)  
 5 Recommended through-holes for wall mounting via socket head screws

→ Flow direction

Type	D1	B1	B2	B3	B4	B5	B6	B7	D2	D3	D4	D5	D6
FRC-1/4-DB	G1/4	152	98	47	78	44	34	5	∅ 32	M4	M36x1.5	∅ 39	∅ 5.6

Type	H1	H2	H3	L1	L2	L3	L4	L5	L6	L7	L8	L9	L10	T1	± 1
FRC-1/4-DB	40	20	10	189	136	60 min.	113	91	66	42	17	11	2	9	14

Ordering data			
Condensate drain	Size	Connection	Grade of filtration 40 µm
			Part No. Type
Pressure gauge with outer scale in bar and inner scale in psi			
Manual rotary	Mini	G1/4	<b>8002801 FRC-1/4-DB-7-MINI-KC</b>

## Service unit combinations FRC-K, D series

Accessories

FESTO

Filter cartridges, D series, metal design



Ordering data			
Size	Grade of filtration [µm]	Part No.	Type
Mini	40 (colour: white)	363665	LFP-D-MINI-40M
Midi	40 (colour: white)	363667	LFP-D-MIDI-40M
Maxi	40 (colour: white)	363664	LFP-D-MAXI-40M

Filter cartridges, D series, polymer



Ordering data			
Size	Grade of filtration [µm]	Part No.	Type
Mini	40	534502	MS4-LFP-E

Special oil





Ordering data			
Scope of delivery		Part No.	Type
1 litre		152811	OFSW-32

## Service unit combinations FRC-K, D series

FESTO

Accessories

Ordering data – Angled socket PEV					Technical data → Internet: pev-1/4	
	Description	Operating voltage range	Electrical connection	Switching status display	Part No.	Type
	for PEV-1/4-...-OD	15 ... 30 V DC	4-pin	Yellow LED	<b>164274</b>	<b>PEV-1/4-WD-LED-24</b>
		≤ 230 V AC ≤ 180 V DC	4-pin	Yellow LED	<b>164275</b>	<b>PEV-1/4-WD-LED-230</b>

Ordering data – Plug socket MSSD					Technical data → Internet: mssd	
	Description	Operating voltage range	Electrical connection	Type of mounting cable connection	Part No.	Type
	for PEV-1/4-...-OD	≤ 250 V AC/DC	3-pin	Clamping screws	<b>171157</b>	<b>MSSD-C-4P</b>
	for on-off valve HEE	≤ 250 V AC/DC	3-pin	Clamping screws	<b>151687</b>	<b>MSSD-EB</b>
			4-pin	Insulation displacement technology	<b>192745</b>	<b>MSSD-EB-S-M14</b>

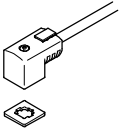
Ordering data – Plug socket with cable KMEB						Technical data → Internet: kmeb	
	Description	Operating voltage range	Electrical connection	Switching status display	Cable length [m]	Part No.	Type
	for on-off valve HEE	24 V DC	3-pin	LED	2.5	<b>151688</b>	<b>KMEB-1-24-2,5-LED</b>
					5	<b>151689</b>	<b>KMEB-1-24-5-LED</b>
					10	<b>193457</b>	<b>KMEB-1-24-10-LED</b>
		230 V AC	3-pin	-	2.5	<b>151690</b>	<b>KMEB-1-230AC-2,5</b>
					5	<b>151691</b>	<b>KMEB-1-230AC-5</b>

Ordering data – Illuminating seal MEB-LD				Technical data → Internet: meb	
	Description	Operating voltage range		Part No.	Type
	for plug socket with cable KMEB and plug socket MSSD-EB	12 ... 24 V DC		<b>151717</b>	<b>MEB-LD-12-24DC</b>
		230 V DC/AC ±10%		<b>151718</b>	<b>MEB-LD-230AC</b>