

Three-point grippers DHDS

FESTO



Three-point grippers DHDS

Key features

FESTO

At a glance

General information

- Resilient and precise T-slot guide of the gripper jaws
- High gripping forces with compact dimensions
- Gripper jaw centring options
- Max. repetition accuracy
- Gripping force retention
- Internal fixed flow control
- Wide range of options for mounting on drive units

- Sensor technology:
 - Adaptable position sensor for the small gripper sizes
 - Integratable proximity sensors for the medium and large gripper sizes

Flexible range of applications

- Can be used as a double-acting and single-acting gripper
- Compression spring for supplementary or retaining gripping forces
- Suitable for external and internal gripping

The technology in detail

Gripper closed

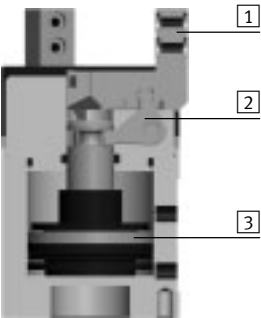

Gripper open

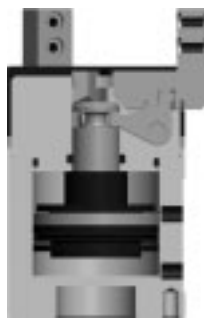

- 1 Gripper jaw
- 2 Reversing lever
- 3 Piston with magnet

-  - Note
Gripper selection
sizing software
→ www.festo.com

Position sensing/force control

With position transmitter SMAT-8M



Analogue positional feedback possible

- Analogue output 0 ... 10 V

With proportional pressure regulator VPPM



Infinite adjustment of the gripping force possible

- Setpoint input
 - 0 ... 10 V
 - 4 ... 20 mA

With proximity sensor SMT-8G



Multiple positions can be sensed:

- Open
- Closed
- Workpiece gripped

Three-point grippers DHDS

Key features

Supply ports

At the side

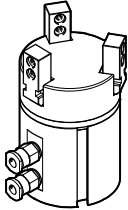

Mounting options

Size 16

Size 32, 50

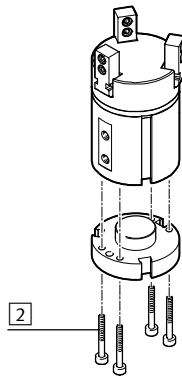
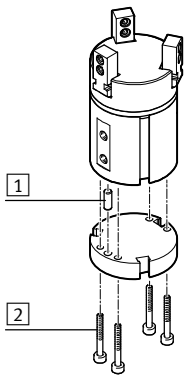

- 1 Centring pin
- 2 Mounting screws

Mounting options for external gripper fingers

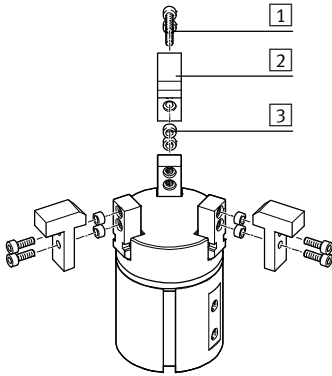

- 1 Mounting screws
- 2 Gripper fingers
- 3 Centring sleeves

-  - Note

These grippers are not designed for the following or similar sample applications:

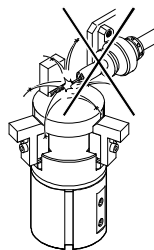

- Welding spatter

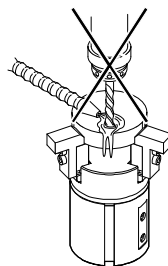

- Machining
- Aggressive media

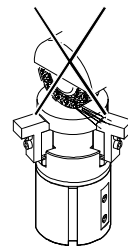

- Grinding dust

Three-point grippers DHDS

Peripherals overview

FESTO

Peripherals overview

DHDS-16

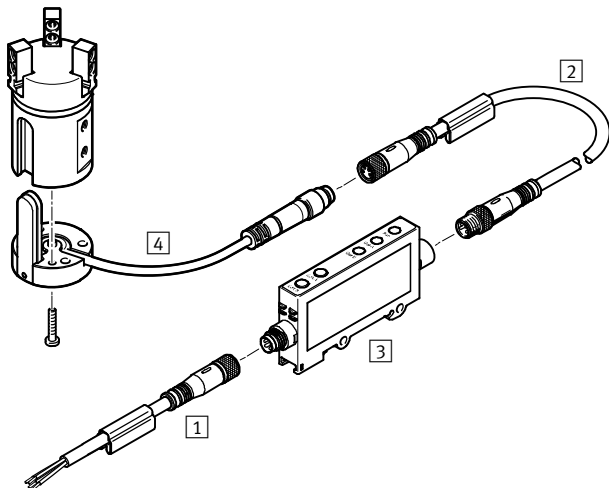

DHDS-32, 50

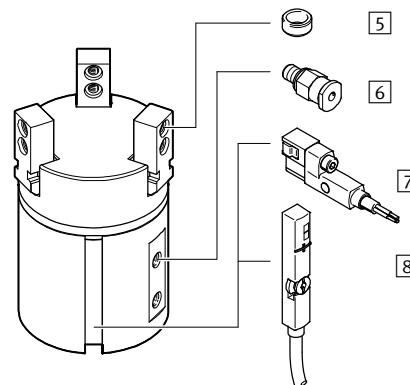

System product for handling and assembly technology

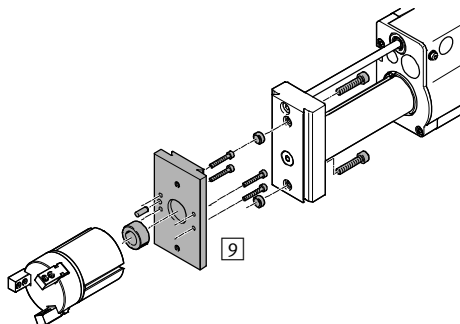

Proportional pressure regulator VPPM

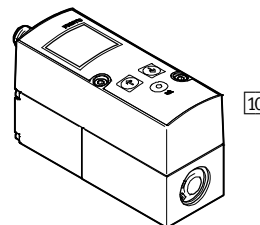

Accessories			
Type	Size	Description	→ Page/Internet
1 Connecting cable NEBU	16	• Connection between signal converter and controller	16
2 Connecting cable NEBU	16	• Connection between position sensor and signal converter	16
3 Signal converter SVE4	16	• For evaluating signals for position sensor SMH-S1	16
4 Position sensor SMH-S1	16	• Adaptable and integratable sensor technology, for sensing the piston position	16
5 Centring sleeve ZBH	16 ... 50	• For centring the gripper fingers on the gripper jaws • The scope of delivery of the gripper includes 6 centring sleeves	16
6 Push-in fitting QS	16 ... 50	• For connecting compressed air tubing with standard O.D.	qs
7 Proximity sensor SMT-8G	32, 50	• For sensing the piston position • Proximity sensor does not project past the housing at the bottom	17
8 Position transmitter SMAT-8M	32, 50	• Continuously senses the position of the piston. Has an analogue output with an output signal in proportion to the piston position.	17
9 Adapter kit DHAA, HMSV, HAPG, HMVA	16 ... 50	• Connecting plate between drive and gripper	14
10 Proportional pressure regulator VPPM	16 ... 50	• For infinite adjustment of the gripping force	vppm

Three-point grippers DHDS

Type codes

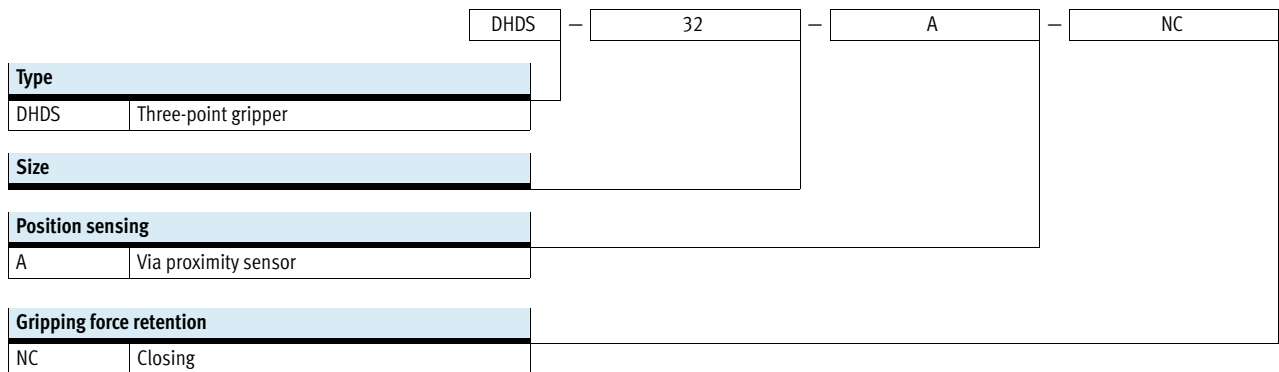

Three-point grippers DHDS

Technical data

FESTO

Function
Double-acting
DHDS-...-A

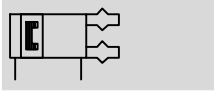

Function – Variants
Single-acting or
with gripping force retention ...
... closing DHDS-...-NC



- Size
16 ... 50 mm
- Stroke
2.5 ... 6 mm
- www.festo.com

General technical data			
Size	16	32	50
Design	Lever Forced motion sequence		
Mode of operation	Double-acting		
Gripper function	Three-point		
Gripping force retention	NC	NC	NC
Number of gripper jaws	3		
Max. load per external gripper finger ¹⁾ [g]	50	150	250
Stroke per gripper jaw [mm]	2.5	3.9	6
Pneumatic connection	M3	M5	G1/8
Repetition accuracy ²⁾ [mm]	≤ 0.04		
Max. interchangeability [mm]	≤ ±0.2		
Max. operating frequency [Hz]	≤ 4		
Rotational symmetry [mm]	< Ø 0.2		
Position sensing	Via position sensor	Via proximity sensor, position transmitter	
Type of mounting	Via female thread and dowel pin		
Mounting position	Any		

- 1) Valid for unthrottled operation
- 2) End-position drift under constant conditions of use with 100 consecutive strokes, concentric to the central shaft

Operating and environmental conditions		
Min. operating pressure		
DHDS-...-A [bar]		2
DHDS-...-A-NC [bar]		4
Max. operating pressure [bar]		8
Operating medium	Compressed air in accordance with ISO 8573-1:2010 [7:4:4]	
Note on operating/pilot medium	Operation with lubricated medium possible (in which case lubricated operation will always be required)	
Ambient temperature ¹⁾ [°C]		+5 ... +60
Corrosion resistance class CRC ²⁾		1

- 1) Note operating range of proximity sensors
- 2) Corrosion resistance class CRC 1 to Festo standard FN 940070
Low corrosion stress. For dry indoor applications or transport and storage protection. Also applies to parts behind covers, in the non-visible interior area, and parts which are covered in the application (e.g. drive trunnions).

Weight [g]			
Size	16	32	50
DHDS-...-A	96	276	920
DHDS-...-A-NC	99	281	932

Three-point grippers DHDS

Technical data

Materials

Sectional view

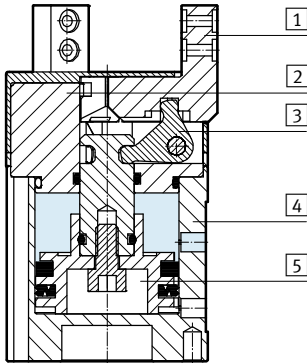

Three-point gripper

1	Gripper jaw	High-alloy stainless steel
2	Cover cap	Polyamide
3	Reversing lever	Hardened sintered steel
4	Housing	Hard anodised wrought aluminium alloy
5	Piston	Polyacetal
-	Note on materials	Free of copper and PTFE RoHS-compliant

Gripping force [N] at 6 bar

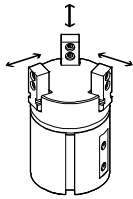

Size	16	32	50	
Gripping force per gripper jaw				
DHDS-...-A	Opening	40	135	280
	Closing	29	115	250
Total gripping force				
DHDS-...-A	Opening	120	405	840
	Closing	87	345	750

Characteristic load values at the gripper jaws

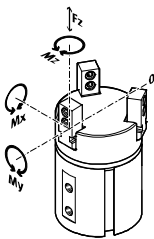

The indicated permissible forces and torques apply to a single gripper jaw. They include the lever arm, additional applied loads due to the workpiece or external gripper fingers and acceleration forces occurring during movement.

The zero coordinate line (gripper finger point of rotation) must be taken into consideration for the calculation of torques.

Size	16	32	50	
Max. permissible force F_z	[N]	50	150	250
Max. permissible torque M_x	[Nm]	2	9	24
Max. permissible torque M_y	[Nm]	2	9	24
Max. permissible torque M_z	[Nm]	2	9	24

Three-point grippers DHDS

Technical data

Mass moment of inertia [kgcm²]

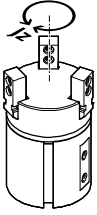

Mass moment of inertia of the three-point gripper in relation to the central axis, without external gripper fingers, without load.

Size	16	32	50
DHDS-...	0.14	0.79	6.10
DHDS-...-NC	0.14	0.82	6.18

Gripper jaw backlash

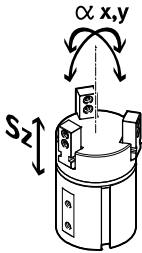

The plain-bearing guide used in the grippers means that there is backlash between the gripper jaws and the housing. The values entered in the table for the backlash were calculated in accordance with the traditional accumulative tolerance method.

Size	16	32	50
Max. gripper jaw backlash Sz [mm]	≤ 0.02		
Max. gripper jaw angular backlash ax, ay [°]	≤ 0.5		≤ 0.2

Opening and closing times [ms] at 6 bar

Without external gripper fingers

With external gripper fingers

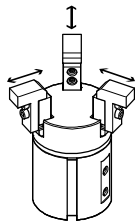
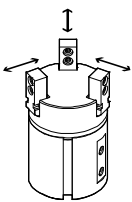

The indicated opening and closing times [ms] were measured at room temperature at an operating pressure of 6 bar with horizontally mounted grippers without additional gripper

fingers. The grippers must be throttled for greater loads [g]. Opening and closing times must then be adjusted accordingly.

Size	16	32	50	
Without external gripper fingers				
DHDS-...-A	Opening	26	44	62
	Closing	42	51	55
DHDS-...-A-NC	Opening	31	55	73
	Closing	34	47	50
With external gripper fingers (as a function of the load per gripper finger)				
DHDS-...	100 g	100	–	–
	200 g	–	100	–
	300 g	–	200	100
	400 g	–	–	200
	500 g	–	–	300

Three-point grippers DHDS

Technical data

Gripping force F_H per gripper jaw as a function of operating pressure and lever arm x

The gripping forces as a function of operating pressure and lever arm can be determined from the following graphs.

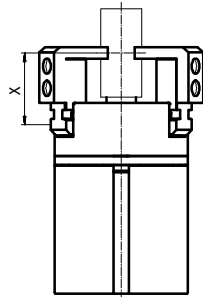

- 2 bar
- - - 4 bar
- · - 6 bar
- · · 8 bar

Note
Gripper selection
sizing software
→ www.festo.com

External gripping (closing)

DHDS-16-A

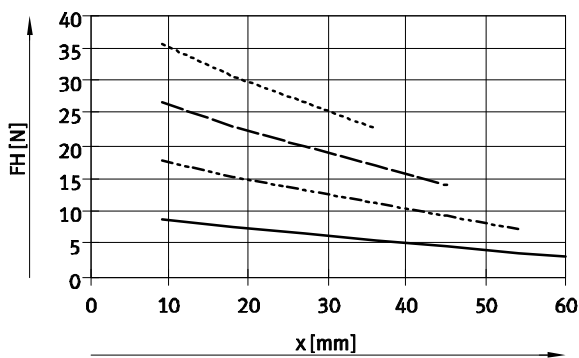

DHDS-32-A

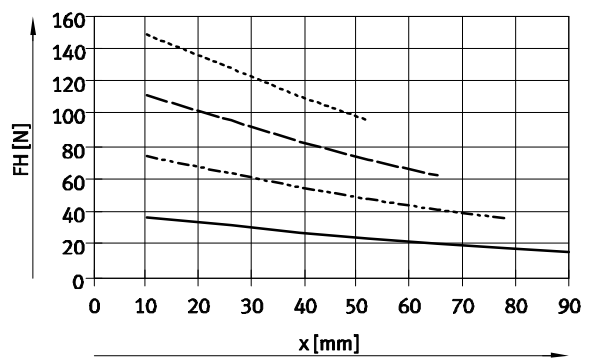

DHDS-50-A

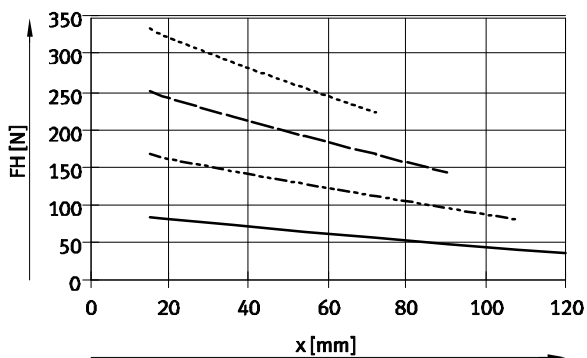

Three-point grippers DHDS

Technical data

Gripping force F_H per gripper jaw as a function of operating pressure and lever arm x

The gripping forces as a function of operating pressure and lever arm can be determined from the following graphs.

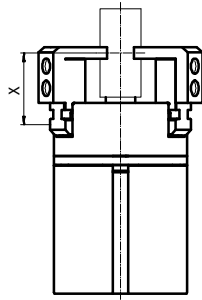

Note
Gripper selection
sizing software
→ www.festo.com

- 2 bar
- - - 4 bar
- · - 6 bar
- · · 8 bar

Internal gripping (opening)

DHDS-16-A

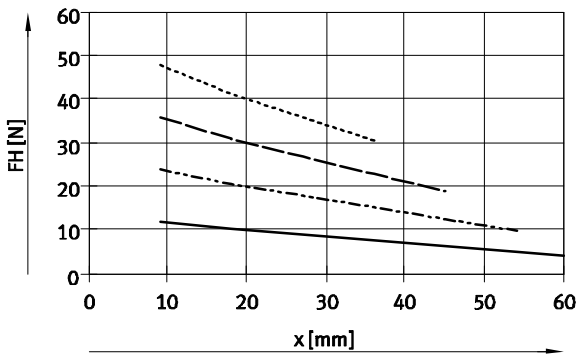

DHDS-32-A

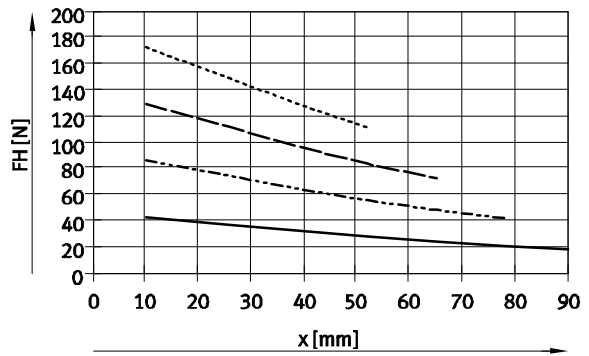

DHDS-50-A

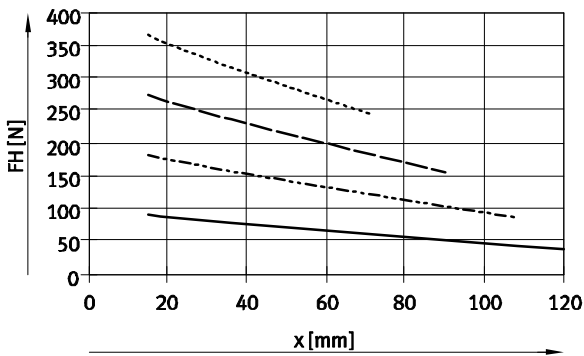

Three-point grippers DHDS

Technical data

Spring force F_F as a function of size and gripper jaw stroke l

Gripping force retention for DHDS-...-NC

The spring forces F_F as a function of gripper jaw stroke can be determined from the following graph.

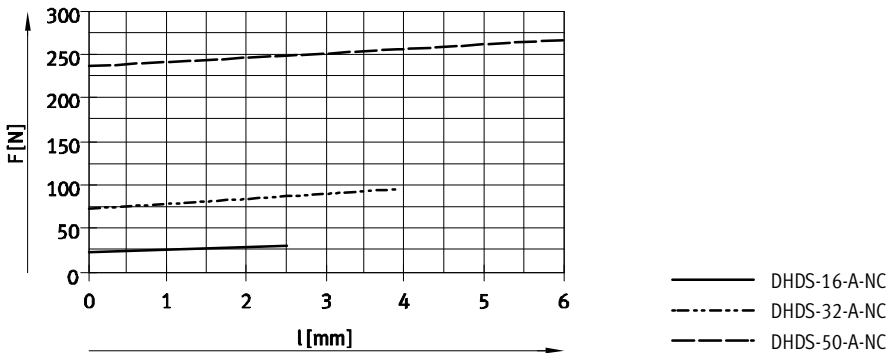
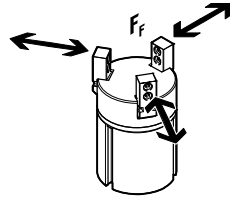

Spring force F_F as a function of size, gripper jaw stroke l and lever arm x per gripper finger

The lever arm x must be taken into consideration when determining the actual spring force F_{Ftotal} . The formulae for calculating the spring force are provided in the table below.

Gripping force retention	Size	F_{Ftotal} per gripper finger
NC	16	$-0.1 * x + 0.33 * F_F$
	32	$-0.2 * x + 0.33 * F_F$
	50	$-0.3 * x + 0.33 * F_F$

Determination of the actual gripping forces F_{Gr} for DHDS-...-NC as a function of application per gripper finger

The three-point grippers with integrated spring type DHDS-...-NC (closing gripping force retention) can be used as:

- single-acting grippers

- grippers with supplementary gripping force and
- grippers with gripping force retention depending on requirements.

In order to calculate the available gripping forces F_{Gr} (per gripper finger), the gripping force (F_H) and spring force (F_{Ftotal}) must be combined accordingly.

Application forces per gripper finger

Single-acting	Supplementary gripping force	Gripping force retention
<ul style="list-style-type: none"> Gripping with spring force: $F_{Gr} = F_{Ftotal}$ Gripping with pressure force: $F_{Gr} = F_H - F_{Ftotal}$ 	<ul style="list-style-type: none"> Gripping with pressure and spring force: $F_{Gr} = F_H + F_{Ftotal}$ 	<ul style="list-style-type: none"> Gripping with spring force: $F_{Gr} = F_{Ftotal}$

Three-point grippers DHDS

Technical data

FESTO

Dimensions

Download CAD data → www.festo.com

DHDS-16

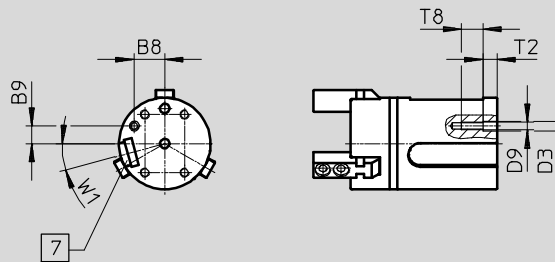

DHDS-32, 50

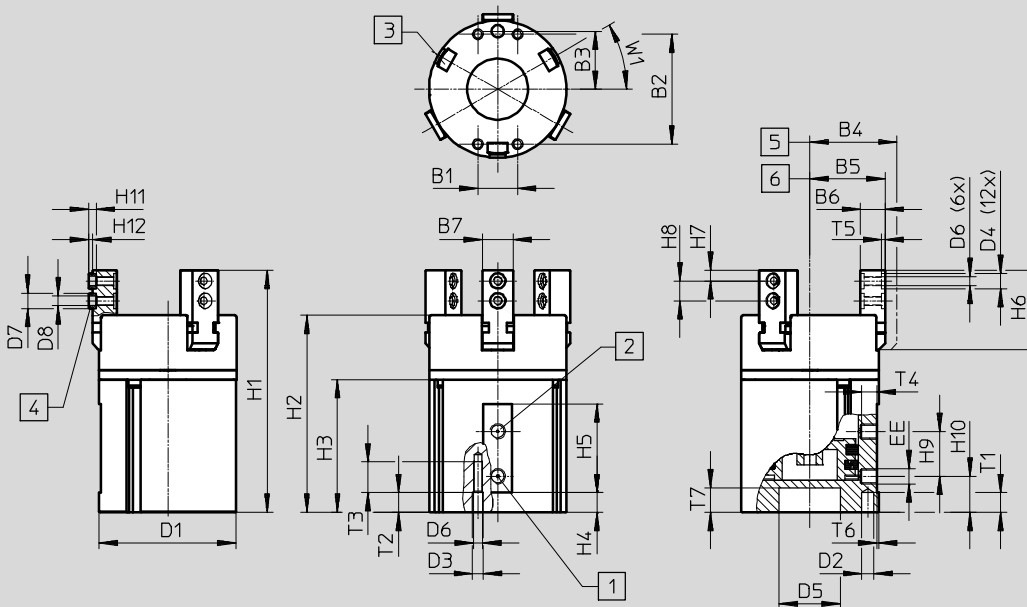

- | | |
|---|----------------------------|
| 1 Supply port, opening | 5 Gripper jaw open |
| 2 Supply port, closing | 6 Gripper jaw closed |
| 3 Slot for proximity sensor | 7 Slot for position sensor |
| 4 Centring sleeve ZBH
(6 included in the scope of
delivery) | |

Three-point grippers DHDS

Technical data

Size	B1	B2	B3	B4	B5	B6	B7	B8	B9
[mm]			±0.02	±0.5	±0.5	-0.02/-0.05	-0.02	-0.1	-0.1
16	13	19	11.5	20	17.5	7	6	9.96	5.75
32	13	36	19	28.5	24.6	8	10	-	-
50	25	54	30	43	37	12	14	-	-

Size	D1	D2	D3	D4	D5	D6	D7	D8	D9
[mm]	∅	∅ H8	∅ H8	∅ H8	∅ +0.05/+0.02		∅ h7	∅	
16	30	3	3.2	5	-	M3	5	3.2	M2.5
32	45	4	3.5	5	20	M3	5	3.2	-
50	70	5	6	7	30	M5	7	5.3	-

Size	EE	H1	H2	H3	H4	H5	H6	H7	H8 ¹⁾	H9
[mm]										
16	M3	60	47.9	32.6	4.5	24	21.5	3	6	12
32	M5	78	63.2	42.2	5.2	29	26	3.5	6.5	14.7
50	G1/8	107.5	86.5	56	6.7	40	37	5	10	22

Size	H10	T1	T2	T3	T4	T5	T6	T7	T8	W1
[mm]		min.	min.	+1	-0.5	+0.1	±0.2		±1	
16	11	4.5	4.5	8	4	1.2	1	-	7	15°
32	10.5	6.5	6.5	10	4	1.1	0.5	8	-	30°
50	16	7	7	18	6	1.6	1	9	-	30°

1) Tolerance for centring hole ±0.02 mm
Tolerance for thread ±0.1 mm

Ordering data										
Size	Double-acting without compression spring					Single-acting or with gripping force retention				
	[mm]	Part No.	Type			Closing	Part No.	Type		
16	1259491	DHDS-16-A				1259492	DHDS-16-A-NC			
32	1259493	DHDS-32-A				1259494	DHDS-32-A-NC			
50	1259495	DHDS-50-A				1259496	DHDS-50-A-NC			

Three-point grippers DHDS

Accessories

FESTO

Adapter kit
DHAA, HAPG, HMSV, HMVA

Material:
Wrought aluminium alloy
Free of copper and PTFE
RoHS-compliant

 Note
The kit includes the individual mounting interface as well as the necessary mounting material.

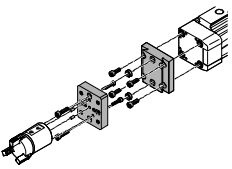
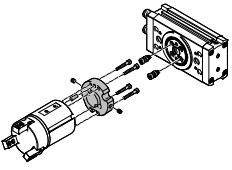
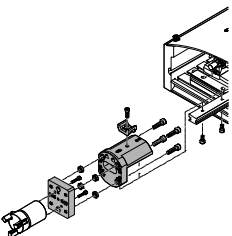
Permissible drive/gripper combinations with adapter kit						Download CAD data → www.festo.com
Combination	Drive	Gripper	Adapter kit			
	Size	Size	CRC ¹⁾	Part No.	Type	
DGP..., DGE-..., DGEA/DHDS	DG...	DHDS	HMVA, HAPG, HMSV			
	Direct mounting					
	18 ²⁾ , 25	16	2	196788	HMVA-DLA18/25	
				193921	HAPG-36-S3	
	40	16		196790	HMVA-DLA40	
				193921	HAPG-36-S3	
	Dovetail mounting					
40	32	2	196790	HMVA-DLA40		
			178212	HMSV-32		
40	50		196790	HMVA-DLA40		
			178213	HMSV-33		
DRRD/DHDS	DRRD	DHDS	DHAA			
	12	16	2	2823512	DHAA-G-Q11-12-B4-16	
	16	16		2136626	DHAA-G-Q11-16-B4-16	
	16	32		2151381	DHAA-G-Q11-16-B4-32	
	20	32		2136339	DHAA-G-Q11-20-B4-32	
	25	32		1471583	DHAA-G-Q11-25-B4-32	
	25	50		1731165	DHAA-G-Q11-25-B4-50	
	32	50		1907040	DHAA-G-Q11-32-B4-50	
	35	50		2135899	DHAA-G-Q11-35-B4-50	
HSP/DHDS	HSP	DHDS	HAPG			
	16	16	2	192705	HAPG-36-S1	
				540882	HAPG-71-B	
	25	16		192705	HAPG-36-S1	
				540883	HAPG-72-B	

1) Corrosion resistance class CRC 2 to Festo standard FN 940070
Moderate corrosion stress. Indoor applications in which condensation may occur. External visible parts with primarily decorative requirements for the surface and which are in direct contact with the ambient atmosphere typical for industrial applications.

2) Only for DGEA-...

Three-point grippers DHDS

Accessories



Adapter kit
HAPG

Material:
Wrought aluminium alloy
Free of copper and PTFE
RoHS-compliant

 Note
The kit includes the individual mounting interface as well as the necessary mounting material.

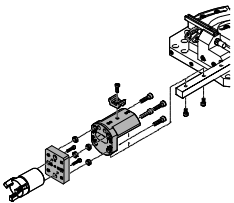
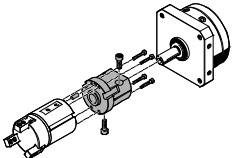
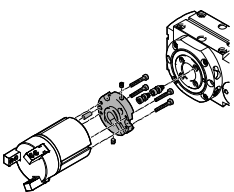
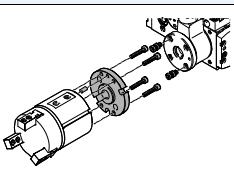
Permissible drive/gripper combinations with adapter kit				Download CAD data → www.festo.com	
Combination	Drive	Gripper	Adapter kit		
	Size	Size	CRC ¹⁾	Part No.	Type
 HSW/DHDS	HSW	DHDS	HAPG		
	16	16	2	192705 540882	HAPG-36-S1 HAPG-71-B
 DSM/DHDS	DSM	DHDS	HAPG		
	8, 10	16	2	187569	HAPG-35
	25	32		163272	HAPG-23
 ERMB/DHDS	ERMB	DHDS	HAPG		
	20	32	2	184481	HAPG-SD2-5
	25	50		184484	HAPG-SD2-8
	32	50		184487	HAPG-SD2-11
 EHMB/DHDS	EHMB	DHDS	HAPG		
	20	50	2	184487	HAPG-SD2-11
	25, 32	50		526026	HAPG-SD2-20

1) Corrosion resistance class CRC 2 to Festo standard FN 940070
Moderate corrosion stress. Indoor applications in which condensation may occur. External visible parts with primarily decorative requirements for the surface and which are in direct contact with the ambient atmosphere typical for industrial applications.

Three-point grippers DHDS

Accessories

FESTO

Ordering data						
	For size [mm]	Comment	Weight [g]	Part No.	Type	PU ¹⁾
Centring sleeve ZBH Technical data → Internet: zbh						
	16, 32	For centring the gripper fingers on the gripper jaws	1	189652	ZBH-5	10
	50		1	186717	ZBH-7	

1) Packaging unit

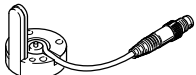
Ordering data						
Type	For size	Weight [g]	Part No.	Type		
Position sensor SMH-S1 Technical data → Internet: smh-s1						
	16	30	175713	SMH-S1-HGD16		

Signal converter/evaluation unit for position sensor SMH-S1

- Converts analogue signals into switching points
- Switching function freely programmable with teach-in
- Threshold value, hysteresis or window comparator

Ordering data						
Type	For size	Input connection	Output connection	Switching output	Weight [g]	Part No. Type
Signal converter SVE4 Technical data → Internet: sve4						
	16	Socket M8x1, 4-pin	Plug M8x1, 4-pin	2x PNP	19	544216 SVE4-HS-R-HM8-2P-M8
				2x NPN		544219 SVE4-HS-R-HM8-2N-M8

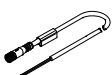
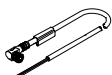
Ordering data – Connecting cables						Technical data → Internet: nebu
	Electrical connection, left	Electrical connection, right	Cable length [m]	Part No.	Type	
Connection between position sensor and signal converter						
	Straight socket, M8x1, 4-pin	Straight plug, M8x1, 4-pin	2.5	554035	NEBU-M8G4-K-2.5-M8G4	
Connection between signal converter and controller						
	Straight socket, M8x1, 4-pin	Cable, open end, 4-wire	2.5	541342	NEBU-M8G4-K-2.5-LE4	
			5	541343	NEBU-M8G4-K-5-LE4	
	Angled socket, M8x1, 4-pin	Cable, open end, 4-wire	2.5	541344	NEBU-M8W4-K-2.5-LE4	
			5	541345	NEBU-M8W4-K-5-LE4	



Three-point grippers DHDS

Accessories

FESTO

Proximity sensor for size 32, 50

Ordering data – Proximity sensors for T-slot, magneto-resistive						Technical data → Internet: smt	
	Type of mounting	Electrical connection, connection direction	Switching output	Cable length [m]	Part No.	Type	
N/O contact							
	Insertable in the slot lengthwise	Cable, 3-wire, lateral	PNP	2.5	547859	SMT-8G-PS-24V-E-2,5Q-OE	
		Plug M8x1, 3-pin, lateral		0.3	547860	SMT-8G-PS-24V-E-0,3Q-M8D	
		Cable, 3-wire, lateral	NPN	2.5	8065028	SMT-8G-NS-24V-E-2,5Q-OE	
		Plug M8x1, 3-pin, lateral		0.3	8065027	SMT-8G-NS-24V-E-0,3Q-M8D	

Ordering data – Connecting cables					Technical data → Internet: nebu	
	Electrical connection, left	Electrical connection, right	Cable length [m]	Part No.	Type	
	Straight socket, M8x1, 3-pin	Cable, open end, 3-wire	2.5	541333	NEBU-M8G3-K-2.5-LE3	
			5	541334	NEBU-M8G3-K-5-LE3	
	Angled socket, M8x1, 3-pin	Cable, open end, 3-wire	2.5	541338	NEBU-M8W3-K-2.5-LE3	
			5	541341	NEBU-M8W3-K-5-LE3	

Position transmitter

The position transmitter continuously senses the position of the piston.
It has an analogue output with an output signal in proportion to the piston position.

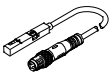
Ordering data – Position transmitters for T-slot						Technical data → Internet: position transmitter			
	For size	Position measuring range	Analogue output		Type of mounting	Electrical connection	Cable length [m]	Part No.	Type
			[V]	[mA]					
	32, 50	0 ... 40	0 ... 10	–	Insertable in slot from above	Plug M8x1, 4-pin, in-line	0.3	553744	SMAT-8M-U-E-0,3-M8D

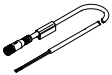
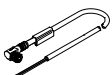
Ordering data – Connecting cables					Technical data → Internet: nebu	
	Electrical connection, left	Electrical connection, right	Cable length [m]	Part No.	Type	
	Straight socket, M8x1, 4-pin	Cable, open end, 4-wire	2.5	541342	NEBU-M8G4-K-2.5-LE4	
			5	541343	NEBU-M8G4-K-5-LE4	
	Angled socket, M8x1, 4-pin	Cable, open end, 4-wire	2.5	541344	NEBU-M8W4-K-2.5-LE4	
			5	541345	NEBU-M8W4-K-5-LE4	